

AVK WATER SUPPLY



WE DELIVER PURE QUALITY
JUST LIKE YOU

Expect... **AVR**





LET'S ENSURE SAFE AND CLEAN WATER FOR EVERYONE

Reliability and purity are crucial when it comes to water supply. AVK products are renowned for superior quality thanks to our market leading expertise when it comes to rubber compounds. Due to own vulcanisation and coating facilities and worldwide approvals for drinking water we can ensure maximum safety and durability.

AVK has been in the valve business for more than 50 years. Today, we are offering solutions for numerous applications, not least valves, hydrants and accessories for water supply. Our wide range includes gate valves, butterfly valves, control valves, check valves, needle valves, air valves, service connection valves and hydrants as well as flange adaptors, couplings, fittings, tapping saddles, repair clamps, surface boxes and valve accessories.

More than 5,300 people in the AVK Group are doing their utmost to ensure that AVK remains one of the world's leading valve manufacturers for water, wastewater, gas, and fire protection applications.



EXPECT LASTING INNOVATIONS



Inhouse R&D

In our Development Department in Denmark, ideas and suggestions for new products are gathered, and existing products are updated continuously.

We use FEA (Finite Element Analysis) to optimise the strength and geometry of our components and CFD (Computational Fluid Dynamics) analyses to validate different product designs prior to creating physical prototypes. This enables us to predict consequences in cases where it is impossible to create full scale tests on physical products.

We make our own test and production equipment, and in our flow lab, we conduct thorough prototype and life cycle tests prior to release for production. New product types are generally field tested in co-operation with end users before final launch.

Quality certifications

AVK's quality management system is certified according to ISO 9001. Moreover, we are certified to the ISO 14001 standard for environmental management, the ISO 50001 standard for Energy Management, and the ISO 45001 standard for occupational health and safety.



EXPECT US TO EXCEED MARKET STANDARDS

Third party certification

Authorities such as DVGW (Germany), KIWA (Netherlands) and UL & FM (the US) offer certification of finished valves, and these are also recognised and accepted by other countries that do not have their own certification schemes.

By obtaining and maintaining the most widely accepted certification, we show our customers that AVK valves always meet the highest quality and safety standards.



Expect... AVK

In our business there are five cornerstones that must be in place in order to meet customer expectations: Quality, reliability, innovation, sustainability and customer service.

But we need to go further than that. We go further to exceed our customers' needs and expectations.

"Expect... AVK" means that our customers should rightfully expect us to exceed market standards. "Expect... AVK" means that we relentlessly strive for increased customer benefits!

To ensure that we keep pushing the boundaries of what the market can expect, we have formulated promises that we will strive to deliver in all our markets:

- EXPECT** A LONG-TERM PARTNERSHIP
- EXPECT** QUALITY IN EVERY STEP
- EXPECT** LASTING INNOVATIONS
- EXPECT** TOTAL SAVINGS
- EXPECT** SOLUTIONS, NOT JUST PRODUCTS
- EXPECT** GLOBAL LEADERSHIP AND LOCAL COMMITMENT
- EXPECT** PROMPT RESPONSE
- EXPECT** IT TO BE EFFECTIVE AND EASY

See more on www.avkvalves.eu



AVK GATE VALVES RENOWNED FOR SUPERIOR QUALITY

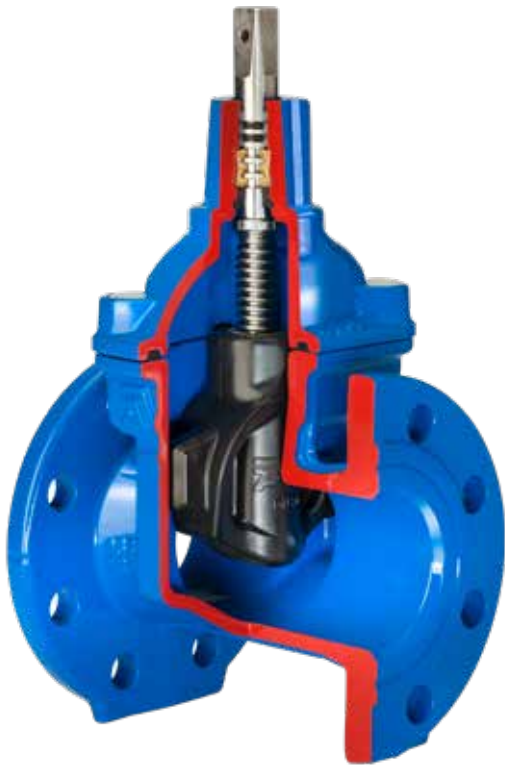

The wedge is the heart of a gate valve and the quality of the wedge rubber is crucial for the valve function and durability. AVK wedges are fully vulcanised with AVK's rubber compound offering outstanding characteristics.

The double bonding vulcanisation process ensures maximum adhesion of the rubber and prevents creeping corrosion.

Fixed wedge nut prevents corrosion

AVK's wedge nut design with a fixed, integral wedge nut outperforms the traditional loose wedge nut design as it prevents vibration and thus also corrosion and malfunction. It is made of dezincification resistant brass certified for use in contact with drinking water according to the stringent EU standards.

Wedge shoes for smooth operation

The fixed wedge nut and the vulcanised wedge shoes secure a smooth operation of the valve and low operating torques. The wedge shoes protect the rubber against wear which otherwise would arise from friction during operation.

State-of-the-art rubber technology

AVK GUMMI A/S develops and manufactures the rubber compound for wedges and gaskets using highly advanced technologies.

Data is collected throughout the entire manufacturing process which secures traceability of every single ingredient, compound and final component. AVK performs a number of tests to ensure that the compression set values, the adhesion and the tensile strength of the rubber meet the predefined requirements.

Safe operation

The large stem hole prevents stagnant water and accumulation of impurities. The large rubber volume in the sealing area combined with the excellent compression set provide optimum sealing.





Efficient bonding is the key to durability

The wedge core is immersed in two different baths to provide ultimate bonding between core and rubber. Even if a sharp object penetrates the rubber during closing of the valve, the bonding is so strong that there is no risk of creeping corrosion. As a result, we offer the best possible corrosion protection of the wedge.

No contamination of drinking water

The EPDM rubber recipes are composed with focus on minimising the formation of biofilm. The rubber will therefore not provide breeding ground for bacteria.

High resistance

The drinking water approved EPDM compounds are resistant to ozone and water treatment chemicals, and are of course taste, smell and colour neutral.

Excellent ability to regain original shape

AVK GUMMI A/S has a profound knowledge of a rubber's compression set, meaning its ability to regain original shape.

Even after many years of service where the wedge rubber has been compressed numerous times, the rubber will regain its original shape and ensure a tight sealing. Impurities will not affect the tightness of the valve, as the impurities will be absorbed in the rubber when the valve is in closed position and will be flushed away when the valve is reopened.



In closed position impurities are absorbed in the rubber



When reopened the rubber will regain its shape

AVK GATE VALVES OFFER UNIQUE FEATURES

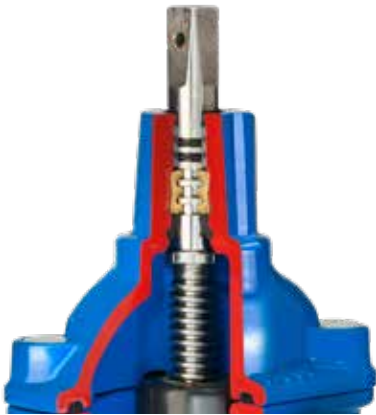

Gate valves DN450-600

In DN450-600 the valves are designed with two roller bearings and a thrust collar of stainless steel to ensure low operating torques.



Gate valves DN800-1200

Thrust washers and nylon bearings are used due to the higher axial forces.

Wedge stop and rolled threads

The wedge stop provides a firm stop against the wedge nut when opening the valve. This prevents the wedge from compressing the stem seals and from damaging the coating inside the bonnet. Therefore, the wedge stop gives prolonged durability of the valve.

The stem threads are rolled in a cold pressing process which maintains the steel structure and therefore increases the strength of the stem. This method also ensures a smooth thread surface that gives low operating torques.

Triple safety stem sealing

An NBR wiper ring protects against impurities from the outside. Tightness and low friction are provided by four NBR O-rings in a polyamide bearing, or optionally a replaceable brass stem nut, preventing galvanic corrosion. An EPDM manchette is the main seal to the flow.

The full circle thrust collar of high strength dezincification resistant brass provides fixation of the stem and low free running torques.

The stem is mounted from below, and the thrust collar expands inside the bonnet and fixes the stem, preventing it from being blown out.

Three strong coatings

The standard corrosion protection is an internal and external fusion bonded epoxy coating in compliance with DIN 3476 part 1 and EN 14901, GSK approved. We control each batch of epoxy coated components to ensure a layer thickness of minimum 250µ, a pore-free surface, high impact resistance and adequate curing. In addition to our own tests, the independent GSK authorities control the adhesion and cathodic disbonding of the epoxy coating according to their guidelines.

Furthermore, we offer gate valves with a highly wear-resistant internal enamel lining offering excellent protection against creeping corrosion.

We also offer an external polyurethane (PUR) coating which gives outstanding protection of the valve against galvanic corrosion, shielding the valve completely from its surroundings. In addition, it eliminates any risk that electrical currents will penetrate the valve and gives additional protection when installed in aggressive soils. The polyurethane coating is quality tested according to EN10290 type 2, class B.



Tight assembly of valve body and bonnet

An EPDM bonnet gasket is fixed in a recess in the bonnet to prevent blow-out. The stainless steel bonnet bolts are encircled by the bonnet gasket, embedded in the casting to ensure that no threads are exposed to the surroundings, and finally sealed with hot melt to prevent corrosion.

Strong PE end connection

A fully welded PE pipe system offers a lot of benefits such as reduced risk of leakage, ease of installation and a high durability. With AVK's comprehensive range of gate valves with PE pipe ends you can design a fully welded PE pipe system up to 630 mm.

A piece of standard PE pipe is pressed directly onto the grooved valve end. The grooves combined with a sleeve around the valve/pipe connection ensure that the PE pipe material is firmly secured and that the connection remains tight and tensile during the entire service life of the pipeline. The connection is sealed with a shrink hose to provide corrosion protection.

Pressure test

Every single valve is pressure tested according to EN 1074-1 and 2 / EN 12266 before leaving the factory.



Feature summary

- Fixed, integral wedge nut prevents corrosion caused by vibration
- Wedge and body guide rails ensure stable operation
- AVK's wedge rubber has an excellent ability to regain its shape
- AVK's wedge rubber features an excellent bonding, minimum formation of biofilm and a high resistance to water treatment chemicals
- Wedge shoes protect the rubber against wear
- Large stem hole in the wedge prevents stagnant water
- Rolled threads increase the stem's strength
- Anti-blowout stem design
- Wedge stop protects seals and coating
- Triple safety stem sealing
- Thrust collar provides fixation of the stem and low free running torques
- Bonnet gasket is fixed in recess and encircles bonnet bolts to prevent blow-out
- Countersunk bonnet bolts sealed with hot melt to protect against corrosion
- Full bore ensures low head loss and enables use of pipe cleaning devices
- Low operating torques ensure easy operation
- Fusion bonded epoxy coating in compliance with DIN 3476 part 1 and EN 14901, GSK approved, optionally internal enamel and external PUR coating

AVK DOUBLE ECCENTRIC BUTTERFLY VALVES THE SAFE CHOICE



AVK offers double eccentric butterfly valves in DN150-2800 designed with durability in focus. The tilted and firmly secured disc, the optimised seal design and the corrosion protected shaft end zones are features that exceed the market standards.

Longer service life due to tilted disc

The tension on the disc is released after a few degrees of opening which minimises wear of the disc seal. Furthermore, the design minimises the compression of the sealing which ensures low operating torques.

Safe disc and shaft connection

The disc and shaft are connected by means of a key and a keyway. The key is secured with two set screws to prevent fluttering caused by flow velocity and necessary play in the key and keyway connection. In the large dimensions the disc is secured with two stainless steel drive dowels, with key and keyway as back-up.

Three seat designs

The integral seat design has a machined and epoxy coated ductile iron seat integrated in the body. The stainless steel seat design comes in two variants. One with a replaceable seat ring of stainless steel sealed with an O-ring to avoid leakages under the seat ring and one with a welded stainless seat machined and polished to give a smooth surface.

Disc seal optimised for high performance

The disc seal is shaped to secure fixation in correct position providing a very reliable function. The excellent rubber quality makes it possible to reduce the amount of rubber which ensures low closing torques. The EPDM sealing is approved by DVGW, KIWA and WRAS.

The stainless steel retainer ring keeps the disc seal in place. It is fixed with stainless steel bolts coated with precoat 80 to prevent loosening. The threaded bolt holes in the disc are corrosion protected with O-rings around the bolt heads.





Shaft design features

The shaft sealing is replaceable under pressure to enable easy maintenance. Sealings of EPDM secure tightness from inside and out, and NBR sealings protect against impurities and fluids from outside.

The low friction PTFE bearings ensure low operating torques and the protected shaft ends secure durability since there are no uncoated ductile iron surfaces exposed to the media.

Bi-directional and slim

The valves are bi-directional even though valves from DN700 and up are marked with an arrow

indicating the preferred flow direction. The weight is minimised to make handling easier, and to put less strain on the environment.

Product approvals

The butterfly valves are approved by:

- DVGW in DN150 - 1200
- KIWA in DN200 - 800
- WRAS in DN900 - 1200

Actuation of your choice

AVK can offer any type of actuation. Our standard options are IP67 gearboxes with handwheel for above ground installation, IP68 gearboxes for buried service, and ISO-input

gearboxes for mounting of electrical actuators. Furthermore, we offer extension stems, adaptors and handwheels.

Up to DN600 the shaft ends are protected with stainless steel plates with gaskets.

After mounting and successful pressure test, an extra layer of epoxy coating seals the steel plates. In larger dimensions the shaft ends are fully encapsulated in the disc and fixed to the disc with dowels.



AVK CENTRIC BUTTERFLY VALVES FIXED OR LOOSE LINER



AVK offers the widest range of butterfly valves at the market. The fixed liner butterfly valves from AVK are among the very few of its kind and offer outstanding advantages. Furthermore, we offer a wide range of loose liner butterfly valves.

Unique fixed liner design

An outstanding seating concept is the heart of the valve. The rubber is injection moulded directly on the valve body forming a permanent bond with an optimal rubber shore hardness. Consequently, there is no risk of deformation or dislocation of the liner and the valves are therefore suitable even under vacuum conditions.

The disc has a profiled sealing edge which requires minimal deformation of the liner to achieve a tight sealing. This gives less wear of the liner and low operating torques.

Feature summary

- Fixed liner with no risk of deformation or dislocation, thus suitable under vacuum conditions
- AVK rubber liner with excellent ability to regain shape after compression
- Disc with profiled sealing edge gives less wear of liner
- Low operating torques due to fixed liner, profiled disc and shaft bearings
- Streamlined disc prevents turbulence, pressure drops and valve vibration
- Available as wafer, semilug, full lug, double flanged short and double flanged long in DN40-2000 with any type of actuation

No turbulence or pressure drops

The streamlined disc gives low flow resistance when the valve is open. Therefore, the valves will not cause any turbulence, pressure drops or valve vibration, and will reduce energy costs for the user.



Profiled disc and unique AVK rubber ensure exceptional durability

The unique AVK rubber compound has an excellent ability to regain shape after compression, and this ability combined with the profiled disc secure tightness even after thousands of operation cycles.



Wide range with loose liner

AVK's range of loose liner butterfly valves comprises wafer, lug and U-section butterfly valves in DN25-1600 with any type of actuation and with a wide selection of disc and liner materials.

The replaceable liner of drinking water approved EPDM has a very robust construction. Its convex form and integrated lip sealings in the shaft passage ensure a tight connection with the shaft. Moreover, the special shape ensures a unique grip to the body, preventing any relative liner displacement during operation. The integrated gasket faces enable easy installation between flanges.



Feature summary

- Stainless steel shaft with anti-blowout design and position indication
- Square driven disc mechanism with effective power transmission
- Disc of acid-resistant stainless steel with streamlined shape for optimum flow characteristics and polished edges for minimum wear of the liner
- Replaceable EPDM liner with a unique design
- Ductile iron body with extended neck for insulation and 200my fusion bonded epoxy coating

AVK SWING CHECK VALVES ENSURE OPTIMUM PUMP PERFORMANCE



Unique design

By unscrewing a few bolts the bonnet assembly including hinge and disc can be removed from the body. The hinge is tightened around the shaft with bolts to eliminate play and thus ensure durability.



AVK offers a wide range of swing check valves featuring full bore and low head loss resulting in maximum utilisation of the pump capacity. The swing check valves can be installed in both horizontal and vertical positions and are easy to maintain.

AVK swing check valves are available in DN50-600 and feature full bore and low head loss as well as easy access to maintenance and great durability.

Lever and weight

Swing check valves with lever and weight are appropriate for installations with an increased risk of water hammer at standard velocities.

The solution enables visual check and valves in small dimensions offer the possibility of priming by moving the lever manually. The weight is adjustable on the lever to achieve a soft closing against the seat as well as an optimum closing speed to prevent water hammer.

A guard covering the lever and weight eliminates the risk of injuries. Optionally with limit switches for remote monitoring.

Swing check valves with lever and external spring are suitable for high pressure, insufficient back pressure and high flow velocities.

Feature summary

- Bonnet/disc design gives easy access to maintenance
- Disc with steel insert is fully vulcanized with EPDM rubber (up to DN300) ensuring optimum sealing ability
- Lip sealing on the disc ensures tightness
- Light-weight disc requires a minimum of force to open and close the valve
- The disc is mounted in a nylon bushing, which allows it to move slightly both horizontally and vertically to close completely tight also in case of minor impurities in the seat
- Hinge tightened around the shaft with bolts to eliminate play and thus ensure durability
- Full bore ensures low head loss
- Ductile iron fusion bonded epoxy coating in compliance with DIN 3476 part 1 and EN 14901
- Available prepared for limit switch



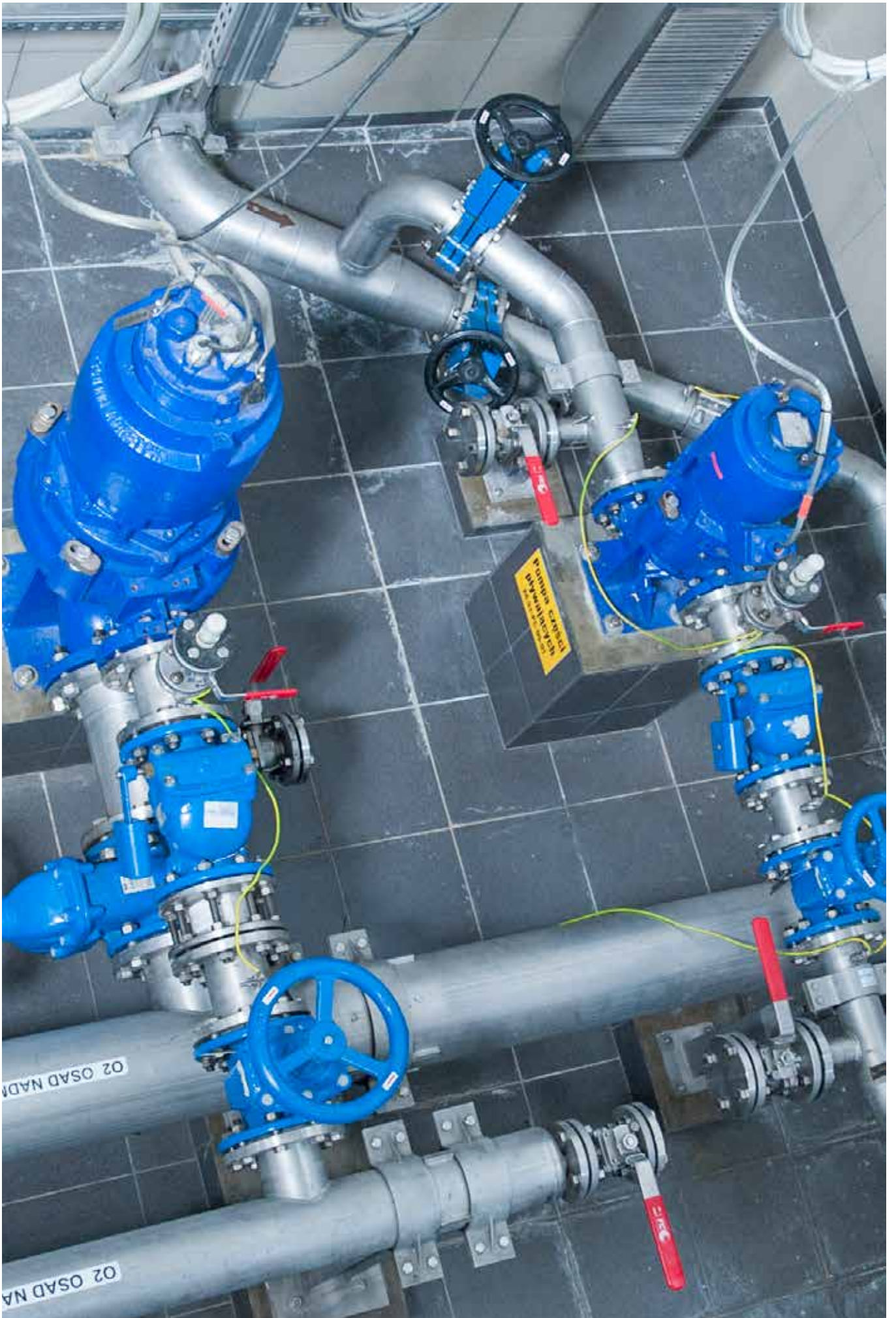

AVK AIR VALVES FOR EFFECTIVE PIPELINE OPERATION



Top performance, minimum maintenance and high durability are the characteristics of AVK's wide range of automatic air valves, air and vacuum valves and combination air valves. The air valves are available in composite materials, which combine strength with extremely light weight and increased venting efficiency.

Why use air valves?

Trapped air pockets in the piping system cause many problems:

- Increased corrosion
- Increased energy consumption and operation costs
- Failure or inaccuracies in flow metering
- Pressure loss or even complete flow stop delays in the filling of mains
- Increased risk of water hammer

Sudden movements of air pockets may result in a rapid change in flow velocity, leading to high pressure surges of a destructive nature.

Automatic air valves

AVK automatic air valves series 701 are designed with a very soft and sensitive seal. It enables effective discharge of accumulated air from the system while under pressure. The automatic air release valve are lightweight and compact with a 12 mm² orifice enabling release of air at high flow rates not being exposed to obstruction by debris. All operating parts are made of specially selected corrosion-resistant materials.

Air and vacuum valves

AVK air and vacuum valves are designed to discharge air during the filling of the system, and to admit air into the system during system drainage. The dynamic design allows for high velocity air discharge while preventing early closure. The special orifice seat design with a combination of bronze and EPDM rubber ensures long-term maintenance-free operation.





Combination air valves

AVK combination air valves combine the function of automatic air release valves and air and vacuum valves. The automatic air release function releases accumulated air from the system while it is under pressure. The air and vacuum function discharges and admits large volumes of air during the filling or draining of pipelines.

The combination air valves are available in four main types:

- Compact design with rolling seat mechanism (series 701/4X)
- A design combining an automatic air valve with the air and vacuum valve (series 701/50 and series 701/60)
- Underground air valve unit (series 701/84)
- Double-float design (series 851)

The underground air valve unit is designed to save manhole costs. It is suitable for frost protection and for installation under important crossings like roads and buildings where manholes would cause dangerous undermining of the ground.

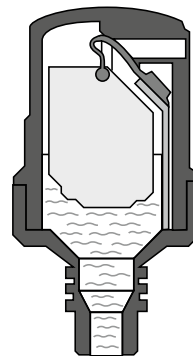

Automatic air valve

For discharge of air liberated from fluid in water mains under pressure

- When air bubbles appear in the valve, the float will drop, allowing air to be released
- When the water rises again, the float will be lifted, and the valve will close

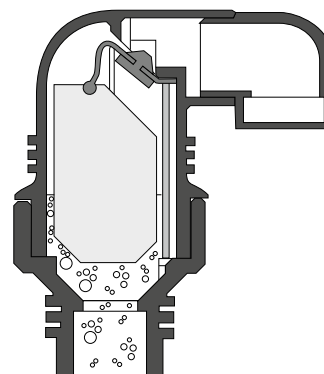

Combination air valve

It combines the function of an automatic air valve with the following:

- When emptying the pipeline, the float will drop completely, allowing large volume air intake through the large orifice
- When refilling the pipeline the water flow will force the air out through the large orifice

AVK CONTROL VALVES DIAPHRAGM OPERATED



The safe choice with 10-year warranty

AVK diaphragm operated control valves are designed according to EN 1074-5 and to provide network stability, accurate regulation, easy maintenance and long durability.

AVK control valves are available in DN50-600, with reduced and with full bore. Control valves with reduced bore are appropriate for most applications, as the smaller bore often offers more accurate regulation. Control valves with full bore are recommended, if high Kv values are needed, e.g. in front of hydrants.

Water is a scarce resource that we need to protect. We need to secure water for the next generations and a growing population. Control valves can help reduce water losses and contribute to efficient water supply management by maintaining a certain pressure, flow or level, regardless of changes in the supply network.

High quality WRAS approved materials

The body and bonnet are made of ductile iron with fusion bonded GSK approved epoxy coating.

The diaphragm is manufactured by AVK GUMMI and made of drinking water approved EPDM rubber with polyamide reinforcement.

All non-coated internals are of stainless steel AISI 316 as standard and all materials are WRAS approved.

Design features of the valve

- Large diaphragm design (1) secures fast reaction to changes in pressure. Its asymmetric axial position gives less stress near closed position.
- Lifted seat design (2) prevents damage inside the valve body caused by cavitation.
- Parabolic plug design (3) provides precise regulation and stability at low flow. Furthermore, it reduces noise and vibration. See below characteristics, illustrating the performance compared to a standard flat plug design.

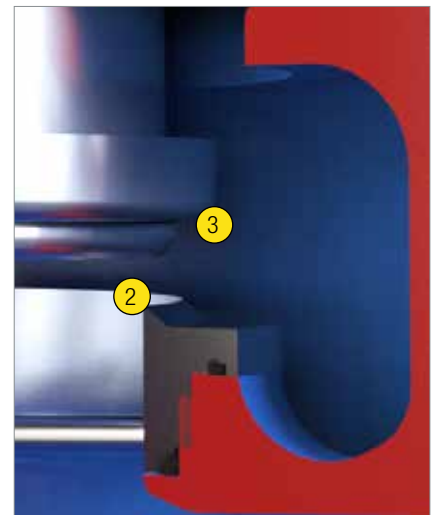
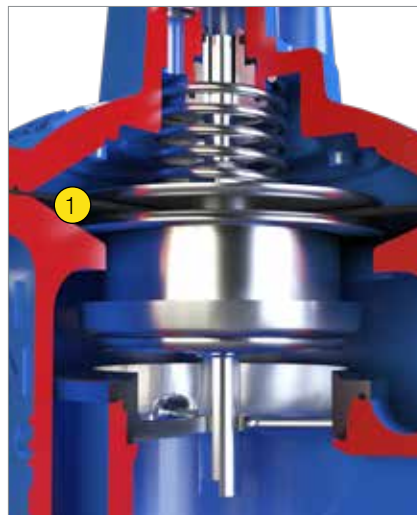
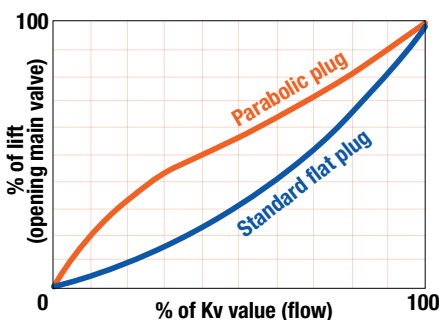

PATENTED PILOT SYSTEM WITH UNIQUE FEATURES



Pressure reducing valve



Pressure sustaining/relief valve

Modular pilot system

The modular design with interchangeable parts offers great flexibility as the pilot system is easily altered to fit other or multiple applications without replacing the valve. The pilot system consists of three main components:

- The distribution block (1) connects the pilot system to the main valve. As a unique feature, it offers adjustment of regulation speed for full control, easily adjusted using standard tooling, and giving full control e.g. in situations, where water hammer may occur.
- The filter (2) features high capacity and easy maintenance. When using the optional flush valve it also offers easy access to cleaning, while the valve is in operation.
- The hydraulic control block (3) can be set up for different applications. It features easy hand adjustment of the balanced pilot valve which is capable of very precise settings.

Compact design

The external pipework takes up less space and is less vulnerable to damage during installation compared to many other control valves.

It is designed using components with standard threads offering easy sourcing of replacements as well as easy fitting using standard tools. All metal parts are of stainless steel AISI 316 as standard.

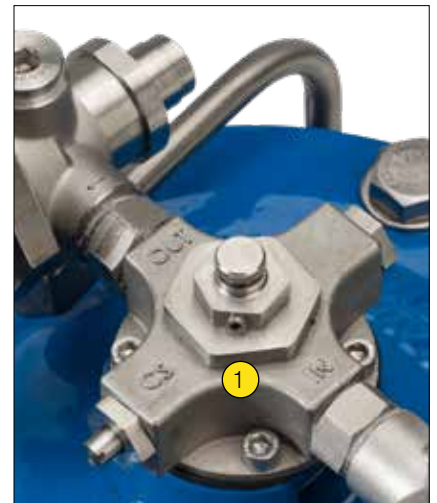

AVK SERVICE CONNECTION VALVES OF DUCTILE IRON, BRASS AND POM



AVK service connection valves are long lasting and maintenance-free. The wedges are made of brass vulcanised with drinking water approved EPDM rubber according to the stringent EU regulations.

Special wedge design

The wedge core is made of dezincification-resistant brass certified for use in contact with drinking water and vulcanised with drinking water approved EPDM rubber externally. The wedge is shaped with wedge guides, and a patented rubber profile ensures low closing torques.

The wedge rubber and vulcanisation is made at AVK GUMMI A/S with the same features and benefits as for mainline gate valves.

POM valves

The bonnet, body and joints of POM (polyoxymethylene) are friction welded ensuring optimum strength. A built-in friction collar prevents overtorque of the valve.

Brass valves

Our brass valves are made of hot forged dezincification-resistant brass certified for use in contact with drinking water and are designed with boltless connection between the body and bonnet. An NBR O-ring is countersunk and compressed when the valve bonnet is screwed onto the body thus ensuring a tight valve.

Ductile iron valves

The design of our ductile iron service connection valves is the same as for the main-line gate valves except for the wedge design. The valves are as standard with internal and external fusion bonded epoxy coating in compliance with DIN 3476 part 1 and EN 14901, GSK approved.

Summary of common features

- Wedge shaped with wedge guides ensures smooth operation
- AVK's wedge rubber has an excellent ability to regain its shape
- AVK's wedge rubber features an excellent bonding, minimum formation of biofilm and a high resistance to water treatment chemicals
- Rolled threads increase the stem's strength
- Thrust collar provides fixation of the stem and low free running torques
- Full bore ensures low head loss
- Low operating torques ensure easy operation

See separate brochure "AVK service connection system" for further details.



Ductile valves

AVK offers a comprehensive range of service connection valves of ductile iron with internal threads, tensile socket ends, PE ends, screw couplings and PRK couplings as well as combinations with external thread.



Brass valves

Our service connection valves of hot forged dezincification resistant brass are available with tensile brass screw couplings or PRK couplings and with AVK or T-type bonnet – all in DN25-50 for 32-63 mm PE pipes.



POM valves

Our service connection valves of POM are available with PRK couplings, tensile socket ends, PE ends, and Pentomech™ couplings, as well as combinations with external thread. In addition, there are options with T-type bonnet.



Wide range of tapping saddles

AVK offers a wide range of tapping saddles. A range that comprises tapping saddles for PE, PVC, ductile iron, cast iron, asbestos cement and steel pipes.

AVK tapping saddles offer easy and fast installation and reliable function and they are maintenance-free and designed to last.

See separate brochure "AVK service connection system" for further details.

AVK SUPA LOCK™ THREADLESS CONNECTION SYSTEM



Connecting valves and fittings with a threaded connection can be time-consuming and often, it leaves part of the thread exposed to the medium and the external environment. Over time this will cause corrosion of the uncoated thread and may even result in a leakage. Supa Lock™ solves this problem.

Full corrosion protection

The patented Supa Lock™ system, provides a 100% corrosion free joint combined with fast and easy assembly with maximum flexibility. Thanks to its simple and ingenious design, Supa Lock™ offers long-term safety with optimum protection against corrosion and leaks and also protection against accidental disassembly of the joint when the pipeline is pressurised.

Valves, tapping saddles and fittings

The wide Supa Lock™ range consists of valves, tapping saddles and fittings in ductile iron with a heavy duty epoxy coating complying with the strict GSK requirements. Furthermore, ball valves and fittings in dezincification resistant brass complying with the EU directive for material used in drinking water installations are part of the range.



Easy two-step assembly
After having lubricated the O-rings, the Supa Lock™ spigot end is pushed into the Supa Lock™ socket end, and the safety retainer is clicked on – and the assembly is done!



Self-locking safety retainer

Supa Lock™ is designed as a tensile joint and withstands pressures up to PN16 x 1.5. The safety retainer is designed with an edge (1), which makes it self-locking whenever there is pressure in the pipeline. Therefore, no accidental disassembly can take place. The safety retainer has two finger knobs (2) for easy assembly and disassembly.



No rotation of valves and connectors

Free rotation is restricted for the valves and the threaded connectors used for drilling machines to enable effective drilling. Small cast notches placed on the outer rim of the socket end and on the inner rim of the spigot end interlock and prevent rotation.

Heavy duty O-rings provide extra safety

All Supa Lock™ joints are fitted with heavy duty Ø7 mm O-rings. They provide extra safety when taking into account that a minor permanent deformation of the O-rings is to be expected over the lifetime of the product. Also, when the joint is exposed to bending as a result of ground movements, the large O-rings provide maximum safety.

360° rotation of fittings

The design allows for a 360° rotation of the fittings, which is a unique feature only offered by the Supa Lock™ system. The free rotation of the joint allows the installer to direct the service pipe outlet in any direction from the main pipe, thus avoiding collision with other pipes or obstacles in the trench.

Corrosion-free access points

For flanged connections in DN80-400, the wafer type spacer with Supa Lock™ socket connections offers a corrosion protected access point to the pipe. It can replace a tapping and in that way avoid weakening of the pipe.

Our range of socket and spigot fittings also serve as access points with no need for tapping the pipe.



AVK SMART WATER SOLUTIONS FOR WIRELESS DIGITAL MONITORING



The AVK Smart Water concept consists of battery-operated wireless IoT sensors for data collection directly from the network. The complex data is turned into valuable insights when integrated into either the existing IT system or into AVK Smart Water's dedicated software platform VIDI Cloud.

Monitoring with state-of-the-art technology

By installing AVK Smart Water sensors in the distribution network, utilities can achieve a transparent network that makes it possible to remotely monitor and diagnose problems, prioritise and manage maintenance issues, and optimise efficiency of the entire network.

Through digital monitoring, AVK Smart Water paves the way for reduced water loss from leaks, increased workflow efficiency and a clearer overview of network conditions.

AVK Smart Water sensors include:

- VIDI Positioner indicating valve position
- VIDI Cap sensor for fire hydrants
- VIDI Open/Close sensor
- VIDI Flow
- VIDI Pressure
- VIDI Temperature sensors
- VIDI Level sensor

We provide data in an easy and accessible way through an API that makes it easy to integrate and combine data for creating a complete overview of the distribution network. We also offer a range of software solutions for visualisation and analysis.

Effectively lower water loss

One of the most efficient methods to reduce leakage and bursts is pressure management. VIDI Pressure sensors provide the data needed to efficiently manage pressure, which will help utilities minimise leaks throughout the distribution network.

In addition, with the leak detection feature in VIDI Cloud, advanced algorithms use data from VIDI Flow sensors to monitor leakage levels. This will enable utilities to prioritise resources and reduce leak run-time.



Due to the wireless nature of IoT, the pressure sensors can be installed at any critical point in the distribution network.

Gate valve installed underground with VIDI Positioner mounted on the extension spindle, detecting when the valve is operated.





Hydrant with VIDI Caps installed. The use of a hydrant affects the pressure in an area. Therefore, it is important for the utility to know when the hydrant is being used in order to distinguish between a pressure drop coming from regular use or from a pipe burst.

With VIDI Caps on hydrants and VIDI Positioners on valves, utilities will receive an alarm when assets are operated. That way, utilities can limit the water loss due to tampering and theft from hydrants and publicly accessible gate valves.

Increase workflow efficiency

Intelligent pressure sensors from AVK Smart Water will provide utilities with the data needed to manage pressure throughout the distribution network. This will result in less truck rolls as there will be fewer bursts to repair and lower energy consumption for pumps as the set point can be reduced, and generally it will extend the lifetime of your assets.

VIDI Pressure and VIDI Temperature provide the transparency needed to efficiently support customers' calls as all relevant network information is ready at hand. Utilities will thus be able to improve customer service while spending less time on support.

VIDI Positioners and VIDI Caps eliminate time wasted on investigating status of valves and hydrants while streamlining maintenance work. The solutions automatically keep track of the latest use and increase efficiency throughout the distribution management.

Better overview of network conditions

There are many risks related to water distribution. Low pressure entails a risk of intrusion of polluted water and poses a serious health risk for consumers. With VIDI Pressure sensors, utilities will be warned if pressure falls below a certain set point.

Hydrants and publicly accessible gate valves are potential entrances for pollutants either by mistake or intentionally. VIDI Caps for hydrants and VIDI Positioners for gate valves help manage this risk by alerting utilities if hydrants or valves are opened.

The overall solution from AVK Smart Water keeps track of the current state of the water network. VIDI sensors register changes in the hydraulic setup, e.g. when a valve is opened or closed or when pressure, temperature or flow is abnormal in the network. With such misconfigurations, there is a risk of loss in hydraulic performance and pressure, which can result in increased energy costs for the utilities.



AVK EXTENSION SPINDLES IN A USER FRIENDLY DESIGN



Extension spindles are used for easy access to operation of valves installed below ground. AVK extension spindles are produced on fully automated state-of-the-art production equipment to ensure a uniform quality.

Our extension spindles are made of corrosion resistant materials and random samples are torque tested with up to 200 Nm to ensure long service life. The inner tube is press fit to the top spanner and the bottom adaptor to safeguard the galvanization of the tube. The bottom cover protects the valve spindle from impurities and enables it to rotate freely.

The "Safe Click" provides a secure and fast mounting process on service connection valves. A quick-mounting clip secures the connection between the stem and the bottom adaptor and allows for mounting and demounting without use of tools.





Fixed length design features easy shortening

Fixed length extension spindles are used when the distance between the valve and the ground surface is known so that adjustment of the length after installation is required to a limited extent or not at all.

The patented AVK design facilitates fast and easy shortening of the extension spindle. The complete adjustment of the length can be done merely by use of a hacksaw. The extension spindles are available with a pipe cover of 800-1000-1500-2000-3000 mm.

Telescopic design facilitates on-site adjustments

Telescopic extension spindles are used when the distance between the valve and the ground surface is unknown and when an adjustment of the extension spindle is required after installation.

The top adaptor is designed with a defrosting hole and with ears that can be fixed into AVK surface boxes and support tiles. A lock spring prevents the telescopic part from collapsing during installation, as it creates friction inside the inner tube.

The blue center sleeve protects against penetration of impurities between the two outer PE pipes.

Telescopic extension spindles with break zone

We also offer variants with break zone in the key adaptor which prevents damage of the valve in cases where a much too high torque is applied. In such cases the break nut of copper alloy is easily replaced, and the extension spindle can still be operated by means of a #20 socket wrench. Spare part sets are available.



Expanding bolt design facilitates easy height adjustment on fixed length extension spindles.



The top spanner and the inner tube are press fit on telescopic extension spindles.



AVK SURFACE BOXES A FULL RANGE



AVK offers a very comprehensive range of surface boxes in various designs and material combinations.

Cast iron surface boxes

The ductile iron surface boxes are available in a floating design and a fixed/floating reversible design. The reversible surface box allows for deflection and internal fixation of telescopic extension spindles from both ends.

The fixed surface boxes of grey cast iron are height adjustable using ductile iron distance rings of a height of 10-50 mm.

Floating surface boxes with great flexibility

The internal fixation of telescopic extension spindles enables height adjustment after installation. The deflection ability secures optimal fit on sloped surfaces.

The large chamber provides easy access for mounting and demounting of the extension spindle, and the closed design protects the extension spindle against impurities.

- Square or round surface plate
- Body of polyamide PA-6 or ductile iron
- Surface plate and lid of ductile iron with black epoxy or blue epoxy coating.



Synthetic surface boxes

Synthetic surface boxes are lightweight, ensuring safe and easy handling in compliance with Health and Safety Regulations.

They are maintenance and corrosion free giving easy access throughout the year with no need to clean or grease the seat to protect against corrosion or frost.

Furthermore, they are silent in traffic zones as the synthetic material absorbs noises, and they are 100% recyclable and heat resistant to max. 250°C.

Designed for tough conditions

The housing is made of PA+ (polyamide with additives) making the surface box suitable for heavy duty application areas in all seasons and conditions.

The material has high impact resistance at low temperatures and is sufficiently heat resistant for safe installation in tarmac roads. The ribs in the housing ensure optimal fixation in the road foundation.

Height adjustable surface boxes

AVK offers a wide range of DIN DVGW approved height adjustable surface boxes specifically designed for tarmac installation. They enable easy and precise installation thanks to flexible positioning of the top part.



Height adjustable surface boxes prevent costly correction after installation and save time and money when roads are renovated.

The variants with reinforced rim offer increased support of the top part making them even more robust and suitable for heavy duty areas.

Fixed height surface boxes

Our Classic fixed height surface boxes are DIN DVGW approved and designed to withstand heavy traffic loads. Therefore, they are often used in medium and heavy duty areas.

Our Futura range is a lightweight and price competitive version and is often used in light to medium duty areas.

Support tiles and top frames

Support tiles significantly increase the support required by surface boxes in weak soils. They also prevent telescopic extension spindles from being pushed back.

Top frames protect surface boxes in green zones and improve the visibility of the surface box. With a top frame, grass will not overgrow the surface box and combined with a support tile, easy access to valves installed below is guaranteed.



Recognisable synthetic lids

Lids made of synthetic material are corrosion free, unattractive to thieves, more aesthetic and lightweight, and in compliance with Health and Safety Regulations.

To prevent the lid from being lifted by the suction of a passing vehicle, the reduced weight is compensated for with a locking clip around the bolt. Furthermore, AVK offers a solution that makes the surface box easily detectable by means of a ferromagnetic detector.



AVK COUPLINGS AND FLANGE ADAPTORS

UNIVERSAL AND DEDICATED



AVK offers a wide range of universal and dedicated couplings, flange adaptors and end caps designed for easy installation.

AVK offers four great Supa® ranges

- Supa® - universal and non-tensile
- Supa One™ - universal and non-tensile
- Supa Plus™ - dedicated and tensile for PE/PVC
- Supa Maxi™ - universal and tensile

Supa® - universal and non-tensile

Straight couplings, step couplings and flange adaptors in DN40-600.

- Drinking water approved EPDM gasket with moulded ribs absorbs minor imperfections in the pipe
- $\pm 4^\circ$ angular deflection

Supa One™ - universal and non-tensile

Straight couplings and flange adaptors in DN80-200.

- Sturdy design according to EN 525
- Only one bolt to be tightened in each end of the coupling
- Gasket of EPDM approved for drinking water with a gasket bridge of stainless steel keeping the gasket in place
- $\pm 4^\circ$ angular deflection

Supa Plus™ - tensile for PE/PVC

Straight couplings, flange adaptors, end caps and gate valves in DN40-300.

- Combined gasket of drinking water approved EPDM rubber with tensile grip segments.
- The compression type gasket makes it easy to insert the pipe, even in large dimensions
- $\pm 3.5^\circ$ angular deflection

Supa Maxi™ - universal and tensile

Straight couplings and flange adaptors in DN50-800, end caps in DN50-400, step and transition couplings in DN50-300, and gate valves in DN80-300.

- According to EN 14525
- Fully universal and tensile on all pipe materials, and even on oval pipes
- Patented SupaGrip™ sealing support system with flexible bracket
- Permanent protection caps
- No re-tightening of bolts
- Gasket of EPDM approved for drinking water
- $\pm 4^\circ$ angular deflection





AVK combi-flanges

The range comprises tensile combi-flanges for PE/PVC and ductile iron pipes in DN50-300, non-tensile for PVC and ductile iron pipes in DN50-600, and non-tensile for steel pipes in DN50-300.

- The design features flexible positioning and chamfering of the pipe
- Up to $\pm 3.5^\circ$ deflection of the pipe is possible even in tensile executions
- The pipe will not move inwards during installation which secures a tight connection

Dismantling joints

AVK dismantling joints are available in ductile iron in two ranges;

- with 8.8 galvanized tie rods in all bolt holes, fusion bonded epoxy coating in DN40-1600 and up to DN2600 with 2-pack epoxy coating

- with A2 tie rods in all bolt holes or in every other bolt hole, GSK approved epoxy coating, available in DN4-1200.

Fabricated couplings

AVK's range of dedicated fabricated couplings comprises non-tensile straight couplings, step couplings and flange adaptors in DN350-2000. The range is suitable for ductile and grey cast iron, steel, uPVC and GRP pipes for water and wastewater applications up to 25 bar.

Our range of universal fabricated couplings comprises non-tensile straight couplings and flange adaptors in DN400-2000 made in carbon steel and feature a wide tolerance of 30 mm up to DN450 and 40 mm from DN500. Optionally the universal couplings and adaptors are available in stainless steel, up to PN40 and in customised design.

Repico® couplings

The Repico® range consists of stainless steel universal couplings in tensile and nontensile versions. Repico® offers a quick and simple connection solution for all pipes with possibility of angular deflection and easy handling due to the compact and light-weight design. The range is available from DN15 and up to DN2000, and with EPDM as well as NBR sealings.

See separate brochure "AVK couplings and adaptors" for further details.

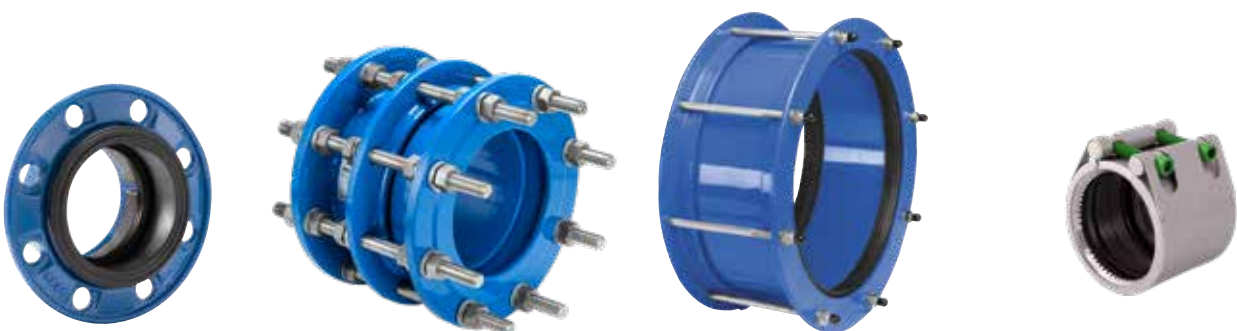

AVK FIRE HYDRANTS ABOVE-GROUND AND UNDERGROUND



AVK offers a wide range of fire hydrants for above and underground installation and in a wealth of variants to meet our customers' needs.

Series 84 Multi hydrant

The Multi hydrant is a modern, slim lined hydrant featuring our standard series 84 below ground barrel with all the components known from our existing range. The upper barrel is made of stainless steel for a modern look, and the hydrant head of ductile iron is epoxy coated and has an extra layer of UV resistant polyester coating.

The head can be machined for several outlet configurations according to customer specifications such as 2 x Storz B or C, 3rd Storz B or C and an optional Storz A on DN100. The Multi hydrant is available with or without traffic break-away design and with single shut-off or double shut-off.

Series 09 above-ground hydrants

Our series 09 hydrants are 360 degrees rotatable and height adjustable for easy installation. In case of traffic knock down the PE pipe, connecting the upper barrel with the foot bend, will just bend and not break.

The hydrants are available of aluminium or ductile iron with manual or automatic drainage, and as top operated or gate valve operated. The automatic drainage hydrant is made in a flush-proof design by means of a membrane drainage valve designed to close when the hydrant is under pressure, and open when the hydrant is shut-off, allowing the water inside the barrel to be drained.

The epoxy coating and an additional topcoat of UV-resistant polyester give a high durability and a strong corrosion protection.





Series 84 above-ground hydrants

Our series 84 hydrants are designed with a double shut-off system for safe sealing of the hydrant during maintenance. The flanges connecting the upper and the lower barrel are assembled with special titanium bushes which are the only spare parts to be replaced in case of an accidental traffic knock down.

The upper part is available in a nostalgic design, a modern stainless steel design and in an execution with a lockable cover protecting against unauthorized operation. The lower part is designed with a PUR vulcanised ductile iron disc and vertical seal like the series 35 hydrants.

Series 84 hydrants are as standard with automatic drainage, and optionally with manual drainage. Back-flow protection can be fitted to protect against contamination of the water through the hydrant. The internal enamel and the external GSK approved epoxy coating with an additional topcoat of UV-resistant polyester give a high durability and a strong corrosion protection.

Series 29 underground hydrants

Our series 29/40 hydrants are based on AVK's renowned gate valve design with fully vulcanized wedge, fixed wedge nut and triple safety stem sealing. It is available with bayonet, Storz or NOR coupling.

Our series 29/50 variant is designed with a riser pipe of stainless steel and an AVK extension spindle.



Free flow hydrant

The series 29/78 hydrant is designed without any parts obstructing the medium. The free flow gives a greatly enhanced flow-rate, it makes the hydrants insensitive to hard particles in the water, and offers easy insertion and retrieval of pipe inspection and maintenance equipment..

Series 35 underground hydrants

Our series 35 hydrants seal vertically which gives a low closing torque and makes them easy to operate. The PUR vulcanised plug features a great compression set which ensures that the PUR will regain its shape after having been compressed. The automatic drainage ensures fully emptying of the hydrant after use. Series 35 is available with single shut-off or with double shut-off for easy maintenance, and optionally with internal enamel coating for extra corrosion protection.







LARGE-SCALE HOSPITAL PROJECT IN DENMARK

The New University Hospital in Odense, New OUH, will be one of the largest new hospitals in Denmark with its 250,000 m² under roof on the 780,000 m² site. The turnkey contract amounts to 953m euros.

It will become a hospital of the future and will be part of Campus Odense – a new town focusing on innovation and development. In addition to the New University Hospital, the new town will host the University of Southern Denmark, Science Park Odense and the new Cortex Park supporting knowledge sharing and networking between the business community, the university and the hospital. Generally, innovative thinking characterises the project, and for easy access, new roads are being established and a tramway is being constructed with two planned stops at the new hospital.

Almost 300 AVK valves and hydrants

All valves and hydrants for the project have been supplied by AVK, mainly gate valves with PE ends for direct welding into the PE pipe system, and a lot of these are in DN300-400 to be used for cooling water. Furthermore, flanged gate valves and ball check valves will be used for the wastewater system, and 12 fire hydrants will be spread over the big site.

The new hospital is expected to open in 2025.

Product	DN	Psc	Application
Gate valves with PE ends series 36, including extension spindles and surface boxes	65-250	117	Water and wastewater
	300-400	76	Water and cooling
Fire hydrants series 84		12	Fire protection
Flanged gate valves series 06	80	56	Wastewater
Ball check valves series 53	80	28	Wastewater



UNDERGROUND FIRE HYDRANTS AND GARDEN FOUNTAIN POSTS



Series 29/40
Underground fire hydrant
with bayonet coupling
DN100
PN16
Ductile iron

- Options:
- 3" stortz oupling
 - 3" NOR coupling
 - 4" stortz coupling



Series 29/50
Underground fire hydrant
with bayonet coupling
With AVK extension
spindle and riser pipe in
stainless steel
DN100
PN16
Ductile iron



Series 29/78
Underground fire hydrant
Free flow
Single shut-off
DN80
PN16
750-1500 mm
Ductile iron



Series 35/31
Underground fire hydrant
Single shut-off
DN80
PN16
750-1500 mm
Ductile iron

- Options:
- stainless steel seat
 - backflow prevention



Series 35/85
Underground fire hydrant
Additional ball shut-off
DN80
PN16
750-1500 mm
Stainless steel seat
Ductile iron



Series 35/72
Underground fire hydrant
DN100-125
PN16
1000-3500 mm
Ductile iron

- Options:
- drilling according to GOST



Series 30
Underground fire hydrant
For mounting on AVK
combi-cross
DN100
PN16
Grey cast iron



Series 80/60
Flexdrain
Packing for underground
hydrant
DN80/100
PP with polyester
spunbond geotextile



Series 78/7510
Fountain post
"VICTORIA"
Frost-proof
DN40
Grey cast iron

- Options:
- outlet for fire hose connection

ABOVE-GROUND FIRE HYDRANTS



Series 84/05
 Above-ground fire hydrant
 Break-away design with
 additional ball shut-off
 Model P7
 DN80/100
 PN16
 Ductile iron

- Options:
- lateral flange



Series 84/72
 Above-ground fire hydrant
 Break-away design with
 additional ball shut-off
 Model P7
 DN80/100
 PN16
 Stainless steel

- Options:
- lateral flange



Series 84/45
 Above-ground fire hydrant
 Break-away design with
 additional ball shut-off
 Model P7
 "NOSTALGIA"
 DN80
 PN16
 Ductile iron

- Options:
- lateral flange
 - various coatings



Series 84/91
 Above-ground fire hydrant
 Breakable
 single shut-off
 Model N7
 DN80/100
 PN16
 Stainless steel

- Options:
- non breakable
 - double shut-off
 - ductile iron

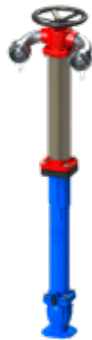

Series 84/93
 Tunnel fire hydrant
 Breakable
 double shut-off
 Model N7
 DN80
 PN16
 Stainless steel



Series 84/26
 Above-ground fire hydrant
 Drop down pillar
 Model P7, Type C
 DN100
 PN16
 Ductile iron

- Options:
- lateral flange



Series 09/30
 Above-ground fire hydrant
 Screw down type B
 DN80
 PN10
 Ductile iron

- Options:
- manual or automatic drainage
 - gate valve operated



Series 09/50
 Above-ground fire hydrant
 Type A
 DN100
 PN10
 Aluminium

- Options:
- manual or automatic drainage

FLANGED GATE VALVES FOR WATER



Series 06/30
Flanged gate valve
Face-to-face DIN F4
DN40-1200
PN10/16
Ductile iron

- Options:
- internal enamel
 - duplex stem
 - replaceable stem sealing



Series 06/52
Premium 100 gate valve
Flanged
Face-to-face DIN F4
DN40-600
PN10/16
External PUR coating
Ductile iron

- Options:
- face-to-face DIN F5



Series 06/35
Flanged gate valve
with position indicator
Face-to-face DIN F4
DN50-400
PN10/16
Ductile iron

- Options:
- face-to-face DIN F5



Series 15/42
Flanged gate valve
with ISO top flange for
actuator
Face-to-face DIN F4
DN40-400
PN10/16
Ductile iron

- Options:
- face-to-face DIN F5



Series 02/60
Flanged gate valve
Face-to-face DIN F5
DN40-500
PN10/16
Ductile iron

- Options:
- internal enamel
 - PN25
 - duplex stem
 - to GOST



Series 02/75
Flanged gate valve
Face-to-face DIN F5
Replaceable stem sealing
DN40-500
PN10/16
Ductile iron

- Options:
- PN25



Series 02/20
Flanged gate valve
Face-to-face BS
DN50-400
PN10/16
Ductile iron



Series 9002
Flanged gate valve for
irrigation
Face-to-face DIN F4
DN40-400
PN10/16
Light blue RAL 5012
No drinking water
approvals
Ductile iron

- Options:
- face-to-face DIN F5



Series 55/30
Flanged gate valve
DN450-500-600-800
Face-to-face DIN F5
PN10/16
Resilient seated
Replaceable stem sealing
Ductile iron

- Options:
- DN80 By-pass



Series 54
Flanged gate valve
DN700-800-900
Face-to-face BS
PN10/16
Metal seated
Ductile iron

- Options:
- DN80 By-pass



Series 18/70
Combi-cross
with 4 outlets
DN100-300
PN10/16
Ductile iron

- Options:
- with ball valve service outlets
 - with blind flange on DN100 centre outlet
 - with 3 outlets
 - DN80 center outlet



Series 18/01
Combi-cross
flexible design
DN100-400
PN10/16
Ductile iron

- Options:
- with ball valve service outlets
 - with blind flange on centre outlet
 - duplex stem

GATE VALVES WITH PE ENDS, SPIGOT, COUPLINGS AND SOCKET ENDS FOR WATER



Series 36/80
Gate valve with PE ends
DN65-500
PE100/SDR11

Od75-630 mm
Ductile iron

- Options:
- SafeTech ends
 - duplex stem
 - PE100/SDR17



Series 36/52
Premium 100 gate valve with PE ends
DN65-400
PE100/SDR11

Od75-400 mm
External PUR coating
Ductile iron

- Options:
- black/blue pipe ends up to 630 mm
 - PE100/SDR17

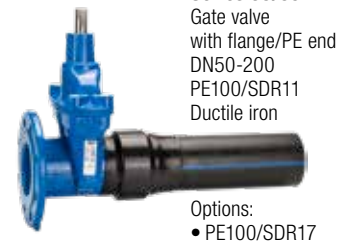

Series 38/80
Gate valve with flange/PE end
DN50-200
PE100/SDR11
Ductile iron

- Options:
- PE100/SDR17

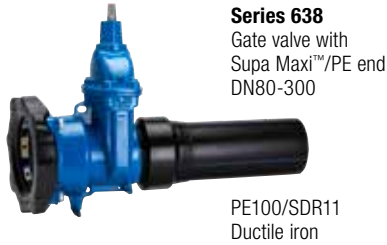

Series 638
Gate valve with Supa Maxi™/PE end
DN80-300

PE100/SDR11
Ductile iron

- Options:
- PE100/SDR17



Series 636
Supa Maxi™ gate valve
Universal and tensile coupling ends for all pipes
DN80-300
PN16
Ductile iron

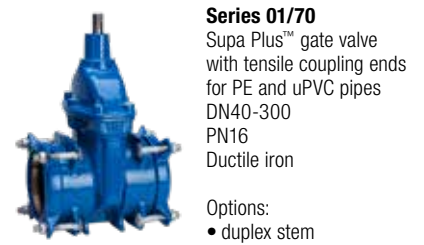

Series 01/70
Supa Plus™ gate valve with tensile coupling ends for PE and uPVC pipes
DN40-300
PN16
Ductile iron

- Options:
- duplex stem

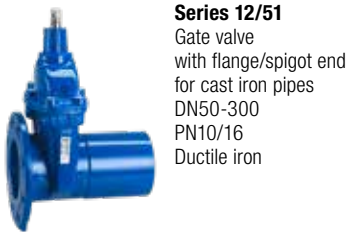

Series 12/51
Gate valve with flange/spigot end for cast iron pipes
DN50-300
PN10/16
Ductile iron

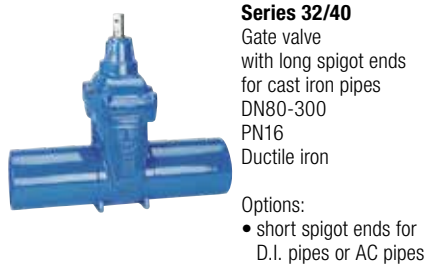

Series 32/40
Gate valve with long spigot ends for cast iron pipes
DN80-300
PN16
Ductile iron

- Options:
- short spigot ends for D.I. pipes or AC pipes

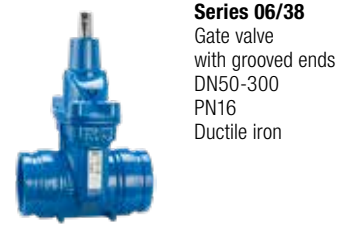

Series 06/38
Gate valve with grooved ends
DN50-300
PN16
Ductile iron

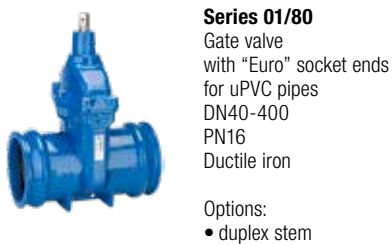

Series 01/80
Gate valve with "Euro" socket ends for uPVC pipes
DN40-400
PN16
Ductile iron

- Options:
- duplex stem

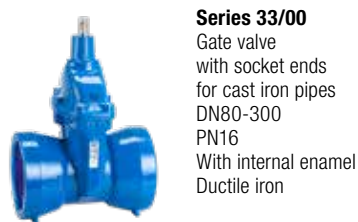

Series 33/00
Gate valve with socket ends for cast iron pipes
DN80-300
PN16
With internal enamel
Ductile iron

- Options:
- internal epoxy

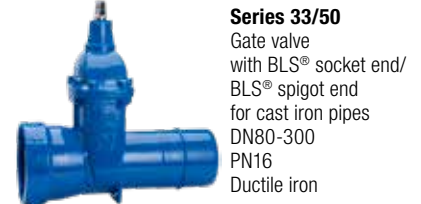

Series 33/50
Gate valve with BLS® socket end/BLS® spigot end for cast iron pipes
DN80-300
PN16
Ductile iron

DOUBLE ECCENTRIC AND CENTRIC BUTTERFLY VALVES



Series 756/100
Butterfly valve
Double eccentric
IP 67 gearbox
DN150-2800
PN10/16
Ductile iron

- Options:
- integral seat / stainless steel seat / welded stainless steel seat
 - internal enamel
 - PN25



Series 756/102
Butterfly valve
Double eccentric
ISO-input gearbox
DN150-2800
PN10/16
Ductile iron

- Options:
- integral seat / stainless steel seat / welded stainless steel seat
 - internal enamel
 - PN25



Series 756/106
Butterfly valve
Double eccentric
IP 68 gearbox
DN150-2800
PN10/16
Ductile iron

- Options:
- integral seat / stainless steel seat / welded stainless steel seat
 - internal enamel
 - PN25



Series 75
Butterfly valve
Centric with fixed liner
Wafer type
DN40-1400
PN10/16
Ductile iron

- Options:
- various actuators



Series 75
Butterfly valve
Centric with fixed liner
Semi-lug type
DN50-200
PN10/16
Ductile iron

- Options:
- various actuators



Series 75
Butterfly valve
Centric with fixed liner
Full lug type
DN50-1200
PN10/16
Ductile iron

- Options:
- various actuators



Series 75
Butterfly valve
Centric with fixed liner
Double flanged short
DN50-2000
PN10/16
Ductile iron

- Options:
- Double flanged long
 - various actuators



Series 820/00
Butterfly valve
Centric with loose liner
Wafer type
DN25-1000
PN10/16
Ductile iron

- Options:
- various actuators



Series 820/10
Butterfly valve
Centric with loose liner
Lug type
DN25-600
PN10/16
Ductile iron

- Options:
- various actuators



Series 820/20
Butterfly valve
Centric with loose liner
U-section type
DN150-1600
PN10/16
Ductile iron

- Options:
- various actuators



Series 813/80
Butterfly valve
Centric with loose liner
Double flanged short
DN350-600
PN10/16
Ductile iron

CONTROL VALVES, NEEDLE VALVES AND CHECK VALVES



Series 859
Control valve
Pressure reducing
DN50-600
PN10/16
Ductile iron/AISI 316



Series 859
Control valve
Pressure sustaining
DN50-600
PN10/16
Ductile iron/AISI 316



Series 859
Control valve
Constant flow
DN50-600
PN10/16
Ductile iron/AISI316



Series 872
Needle valve
DN 80-1600
PN 10/16/25/40
Stainless steel DN80-150
Ductile iron from DN200

Options:

- various actuators and accessories
- up to PN100 and DN2000



Series 41/61
Swing check valve
Resilient seated
Closed bushings
DN50-300
PN10/16
Ductile iron



Series 41/60
Swing check valve
Resilient seated
Free shaft
DN50-300
PN10/16
Ductile iron

Options:

- lever and weight
- lever and spring
- prepared for limit switch



Series 41/36
Swing check valve
Metal seated
With lever and weight
DN350-600
PN10/16
Ductile iron

Options:

- free shaft



Series 41/23
Lever and weight kit
for swing check valve
DN50-300
Ductile iron



Series 41/32
Spring kit
for swing check valve
DN50-300
Ductile iron



Series 41/1
Guard kit
for swing check valve
DN80-300
ABS plastic



Series 876
Nozzle check valve
Single stem
DN50-350
PN10/16
Ductile iron

Options:

- multi stem



Series 903
Silent check valve
Metal seat
PN10/16
Ductile iron

Options:

- PN25
- stainless steel

AIR VALVES AND FLOAT VALVES



Series 701/10
Automatic air valve
Threaded BSP 3/4" or 1"
DN20-25
PN16
Reinforced polyamide

Options:
• brass base



Series 701/20
Automatic air valve
Threaded BSP 1/2", 3/4",
or 1"
DN20-32
PN16
Ductile iron



Series 701/30
Air & vacuum valve
Inlet flange
DN50-300
PN16
Ductile iron



Series 701/40
Combination air valve
DN20, 25 and 50
Threaded BSP 3/4", 1"
or 2"
PN16
Reinforced polyamide



Series 701/46
Combination air valve
High flow
Threaded BSP 2"/DN50-
150 inlet flange
PN16
Ductile iron



Series 701/50
Combination air valve
Inlet flange
DN50-300
PN16
Grey cast iron/
Reinforced polyamide



Series 701/60
Combination air valve
Inlet flange
DN50-300
PN16
Ductile iron



Series 701/84
Underground air valve
installation system
DN50-100
PN16
Air valve box of PVC



Series 851/41
Combination air valve
DN50-200
ABS float
Ductile iron

Options:
• stainless steel float

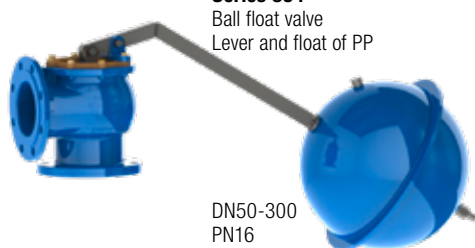

Series 854
Ball float valve
Lever and float of PP

DN50-300
PN16
Ductile iron

Options:
• lever and float of
stainless steel

SUPA LOCK™ THREADLESS CONNECTION SYSTEM



Series 103/00
Service connection valve with Supa Lock™ spigot/socket end
DN32
PN16
Ductile iron

- Options:
- Supa Lock™ spigot end/ PRK coupling
 - duplex stem



Series 103/31
Angle service connection valve with Supa Lock™ spigot/push-in socket end
DN32
PN16
Ductile iron

- Options:
- Supa Lock™ spigot/socket end
 - duplex stem



Series 343/81
Ball valve with Supa Lock™ spigot end/BSP thread
1"-1½"
DN32, PN16
Brass

- Options:
- Supa Lock™ spigot end/ PRK coupling
 - Supa Lock™ spigot end/ screw coupling
 - with T-type bonnet



Series 100/14
Tapping saddle for iron/steel pipes
Ø 60-223 mm
DN32
Ductile iron

- Options:
- for PE/PVC pipes



Series 100/85
Tapping saddle with blade shut-off for iron/steel pipes
Ø 50-360 mm
DN32
Ductile iron/stainless steel

- Options:
- for PE/PVC pipes



Series 107/74
Tapping head with blade shut-off
DN32
Ductile iron



Series 107/31
90° push-in fitting for PE pipes
Ø 32-63 mm
DN32
Ductile iron

- Options:
- straight push-in fitting for PE pipes
 - 45° push-in fitting
 - Supa Lock™ socket end



Series 107/36
Fitting with PE pipe end
Ø 32-63 mm
DN32
Ductile iron



Series 106/01
Fitting with PRK coupling for PE pipes
Ø 32-40 mm
DN32
Ductile iron

- Options:
- double spigot fitting



Series 106/01
Fitting with screw coupling for PE pipes
Ø 32-50 mm
DN32
Brass

- Options:
- PRK coupling
 - sensor fitting



Series 106/02
Threaded connector for connection to drilling machines
1"-2"
DN32
Brass

- Options:
- ductile iron
 - threaded transition connector



Series 109
Spacer for flanged connections
DN80-400
DN32
Ductile iron

- Options:
- 3-way socket fitting
 - 4-way socket fitting
 - socket/tyton fittings
 - blind flange

SERVICE CONNECTION VALVES



Series 03/00
Service connection valve with internal BSP thread
DN25-50
PN16
Ductile iron

Options:
• internal enamel



Series 03/30
Service connection valve with tensile socket ends for PE pipes
DN20-50
PN16
Ductile iron

Options:
• duplex stem



Series 03/40
Service connection valve for side tapping with internal thread /external thread
DN25-50
PN16
Ductile iron



Series 36/5X
Premium 100 service connection valve with PE ends
DN25-50
PE100/PN10

External PUR coating
Ductile iron

Options:
• PE100/PN16



Series 03/65
Service connection valve with tensile screw couplings for PE pipes
DN25-50
PN16
Ductile iron



Series 03/85
Service connection valve with tensile screw coupling for PE pipes / external thread
DN25-32
PN16
Ductile iron



Series 36/8X
Service connection valve with PE ends
DN25-50
PE100/PN10
Ductile iron

Options:
• PE100/PN16
• duplex stem



Series 03/90
Service connection valve with PRK couplings for PE pipes
DN20-50
PN16
Ductile iron

Options:
• internal enamel



Series 16/01
Service connection valve with PRK coupling/ external thread
DN25-50
PN16
POM (Polyoxymethylene)



Series 16/29
Service connection valve with tensile socket end/ external thread
DN25-50
PN16
POM (Polyoxymethylene)



Series 16/50
Service connection valve with tensile socket ends for PE pipes
DN25-50
PN16
POM (Polyoxymethylene)

Options:
• T-type bonnet
• duplex stem



Series 16/59
Service connection valve with Pentomech™ couplings
DN25-50
PN16
POM (Polyoxymethylene)

Options:
• duplex stem

SERVICE CONNECTION VALVES



Series 16/80
Service connection valve
with PE ends
DN25-50
PE100/PN16
POM (Polyoxymethylene)

- Options:
- T-type bonnet
 - long PE end
 - duplex stem



Series 16/90
Service connection valve
with PRK couplings
DN25-50
PN16
POM (Polyoxymethylene)

- Options:
- T-type bonnet
 - duplex stem



Series 16/05
Service connection valve
with tensile screw
couplings for PE pipes
DN25-50
PN16
Brass

- Options:
- T-type bonnet



Series 16/25
Service connection valve
with PRK couplings for
PE pipes
DN25-50
PN16
Brass

- Options:
- T-type bonnet



Series 11/00
Service connection angle
valve with external thread
on inlet and internal
thread on outlet
DN25-50
PN16
Ductile iron



Series 11/30
Service connection angle
valve with external thread
on inlet and tensile socket
end for PE pipes on outlet
DN25-50
PN16
Ductile iron

TAPPING SADDLES



Series 10/00
Tapping saddle
for uPVC and PE pipes
DN50-300
Lower part in stainless
steel from DN250
Ductile iron



Series 10/14
Tapping saddle
for cast iron, ductile iron
and steel pipes
DN50-300
Ductile iron



Series 730/2
Universal tapping saddle
for ductile iron, steel and
other metal pipes
DN50-300
Ductile iron/steel



Series 730
Universal tapping saddle
with blade shut-off
for ductile iron, steel and
other metal pipes
DN50-300
Ductile iron/steel

- Options:
- without blade shut-off



Series 727/10
Tapping saddle
for underpressure drilling
For PE and PVC pipes
DN80-200
Ductile iron



Series 727/20
Tapping saddle SWIC
for underpressure drilling
With integrated cutter
For PE and PVC pipes
OD50-225
Ductile iron



Series 727/21
Tapping saddle SWIC
for underpressure drilling
With integrated cutter for
PVC pipes
OD90-160 mm
Ductile iron



Series 6731
Flanged universal tapping
saddle with blade shut-
off for iron, steel, PE and
PVC pipes
Ductile iron

- Options:
- slim type

VALVE ACCESSORIES



Series 04/02
Extension spindle for gate valves
Fixed length
DN40-400
Polyethylene (PE)

- Options:
- with solid bar



Series 04/04
Extension spindle for gate valves
Telescopic
DN40-600
Polyethylene (PE)

- Options:
- with break zone



Series 04/05
Extension spindle for service connection valves
Fixed length
DN25-50
Polyethylene (PE)

- Options:
- with solid bar



Series 04/F
Extension spindle for service connection valves
Telescopic
DN25-50
Polyethylene (PE)



Series 04/F
Extension spindle for double eccentric butterfly valves
Telescopic
DN200-1200
Polyethylene (PE)



Series 04/15
T-key for gate valves
DN40-400
Steel



Series 04/08/55
Stem caps for gate valves and service connection valves
DN25-600
Ductile iron



Series 08
Handwheel for gate valves
DN50-600
CTC
Grey cast iron

- Options:
- CTO



Series 756/9
Handwheel for double eccentric butterfly valves
DN200-600
Grey cast iron

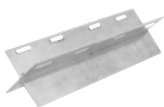

Series 36/15
Valve foundation for gate valves with PE ends
DN25-100
Steel



Series 756/5
Adaptor for connecting gearside to extension rod, wall post indicator or post indicator
DN200-1200
Ductile iron



Series 910
Y-strainer
DN50-300
Ductile iron

SURFACE BOXES



Series 04/10
Fixed surface box
with distance ring
Cast iron with blue epoxy

- Options:
- floating



Series 04/12
Universal surface box
Reversible design
Ductile iron with blue epoxy



Series 04/43
Fixed surface box
Lid of cast iron
Body of PE



Series 04/007
Floating surface box
for telescopic extension
spindle
Flange and lid of ductile iron
Body of PE

- Options:
- round or square surface plate - black epoxy
 - round or square surface plate - blue epoxy



Series 04/008
Floating surface box
for telescopic extension
spindle
Ductile iron with black epoxy

- Options:
- round or square surface plate
 - round or square lid



Series 04/088
Double surface box
Round and square lid
with "V" inscription
Ductile iron with black epoxy



Series 80/30
Surface box "Classic"
according to DIN 4055
for underground hydrants
Fixed height
Body of PA+

- Options:
- oval top
 - rectangular top
 - cast iron lid
 - synthetic lid



Series 80/30
Surface box "Classic"
according to DIN 4055
for underground hydrants
Height adjustable
Cast iron lid
Body of PA+

- Options:
- reinforced rim



Series 80/30
Surface box "Futura"
for underground hydrants
Fixed height
Body of PA+

- Options:
- oval top
 - rectangular top
 - cast iron lid
 - synthetic lid



Series 80/31
Surface box "Classic"
according to DIN 4056
for distribution valves
Fixed height
Body of PA+

- Options:
- round top
 - square top
 - cast iron lid
 - synthetic lid



Series 80/31
Surface box "Classic"
according to DIN 4056
for distribution valves
Height adjustable
Cast iron lid
Body of PA+

- Options:
- reinforced rim



Series 80/31
Surface box "Futura"
for distribution valves
Fixed height
Body of PA+

- Options:
- round top
 - square top
 - cast iron lid
 - synthetic lid

SURFACE BOXES AND ACCESSORIES



Series 80/32
Surface box according to DIN 4057 for service connection valves
Fixed height
Body of PA+

- Options:
- round top
 - square top
 - cast iron lid
 - synthetic lid



Series 80/32
Surface box according to DIN 4057 for service connection valves
Height adjustable
Cast iron lid
Body of PA+

- Options:
- round top
 - square top
 - hexagonal top
 - reinforced rim



Series 80/32
Surface box 4057 "Futura" for service connection valves
Fixed height
Body of PA+

- Options:
- round top
 - square top
 - cast iron lid
 - synthetic lid
 - hexagonal top



Series 80/21
Surface box "Logger" for service connection and distribution valves
Fixed height
Square top
Cast iron lid
PA inscription plates
HDPE body



Series 80/22
Surface box Multi Purpose for service connection valves
Round top
Body of PA+

- Options:
- fixed height
 - height adjustable
 - cast iron lid
 - synthetic lid
 - inscription plate



Series 80/41
Surface box PURBRA for underground hydrants
Fixed height
rectangular top
Cast iron lid
PA inscription plate
HDPE body



Series 80/40
Surface box PERA for distribution valves
Fixed height
square top
Cast iron lid
PA inscription plate
HDPE body



Series 80/42
Surface box PURDIE for service connection valves
Fixed height
square top
Cast iron lid
PA inscription plate
HDPE body



Series 80/46
Support tile for surface boxes for gate valves and service connection valves
HDPE

- Options:
- large spindle fixation
 - small spindle fixation
 - spindle interface



Series 80/46
Support tile for surface boxes for underground hydrants
HDPE



Series 80/46
Top frame for surface boxes
HDPE

- Suitable in combination with various surface boxes:
- for hydrants
 - for distribution valves
 - for service connection valves

SUPA ONE™, SUPA MAXI™, SUPA PLUS™ AND SUPA® COUPLINGS, ADAPTORS, END CAPS AND VALVES



Series 651/00
Supa One™ straight coupling
Universal for ductile iron, steel, PVC and PE pipes
DN80-200
PN16
Ductile iron



Series 653/00
Supa One™ flange adaptor
Universal for ductile iron, steel, PVC and PE pipes
DN80-200
PN16
Ductile iron



Series 636
Supa Maxi™ gate valve
Universal and tensile for all pipes
DN80-300
PN16
Ductile iron

Options:
• Supa Maxi™/PE end



Series 631
Supa Maxi™ straight coupling
Universal and tensile for all pipes
DN50-800
PN16
Ductile iron

Options:
• step coupling



Series 633
Supa Maxi™ flange adaptor
Universal and tensile for all pipes
Universal drilling
DN40-800
PN10/16
Ductile iron



Series 634
Supa Maxi™ end cap
Universal and tensile for all pipes
DN50-400
PN16
Ductile iron



Series 635
Supa Maxi™ transition coupling with PN10 or PN16 pipe end
Universal and tensile for all pipes
DN50-300
PN10/16
Ductile iron



Series 01/70
Supa Plus™ gate valve
Tensile for PE and uPVC pipes
DN40-300
PN16
Ductile iron

Options:
• duplex stem



Series 621/10
Supa Plus™ straight coupling
Tensile for PE and uPVC pipes
DN32-300
PN16
Ductile iron

Options:
• flange adaptor



Series 624/10
Supa Plus™ end cap
Tensile for PE and uPVC pipes
DN40-300
PN16
Ductile iron



Series 601
Supa® straight coupling
universal for uPVC, AC, steel, cast iron and ductile iron pipes
DN40-400
PN16
Ductile iron

Options:
• step coupling



Series 603
Supa® flange adaptor
universal for uPVC, AC, steel, cast iron and ductile iron pipes
Universal drilling
DN40-400
PN10/16
Ductile iron

COMBI-FLANGES, FABRICATED COUPLINGS & ADAPTORS AND DISMANTLING JOINTS



Series 05
Combi-flange for ductile iron pipes
Non-tensile
DN50-300
PN10/16
Ductile iron

Options:
• for PVC pipes



Series 05
Combi-flange for PE and PVC pipes
Tensile
DN50-300
PN10/16
Ductile iron

Options:
• for ductile iron pipes



Series 05
Combi-flange for uPVC, steel or ductile iron pipes
Non-tensile
DN400-600 (uPVC and ductile)
DN50-300 (steel)
PN10/16
Ductile iron



Series 05
Combi-flange sealing for uPVC, steel or ductile iron pipes
Non-tensile
SBR rubber
DN400-600 (uPVC and ductile)
DN50-300 (steel)



Series 05
Support bush for PE pipes
Suitable for Supa Maxi™, Supa Plus™ and combi-flanges
DN50-600
PN6.3/10/16
Stainless steel



Series 745/01
Repico® grip coupling
Universal and tensile for all metal pipes
NBR or EPDM sealing
DN15-400
Stainless steel AISI 316

Options:
• for medium pressure up to DN200
• for PE/PVC pipes



Series 745/20
Repico® slip coupling
Universal and non-tensile for all pipes
NBR or EPDM sealing
DN15-600
Stainless steel AISI 316

Options:
• 2 locks up to DN1000



Series 258
Fabricated dedicated straight coupling for AC, steel, cast iron or ductile iron pipes
DN350-2000
PN8 to 25
Steel

Options:
• step coupling
• flange adaptor

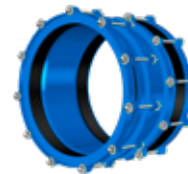

Series 8004
Fabricated universal coupling
DN400-2000
PN16
Steel

Options:
• flange adaptor
• stainless steel



Series 265/30
Fabricated dismantling joint for all pipe materials
DN300-1200
PN10/16/25
Steel

Options:
• with centre flange



Series 265/91
Dismantling joint for all pipe materials
DN40-1200
PN10/16
Ductile iron
GSK coating

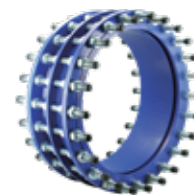

Series 873
Dismantling joint for all pipe materials
With centre flange
DN40-2600
PN10/16/25
Ductile iron

ENCAPSULATION COLLARS, REPAIR CLAMPS AND FITTINGS



Series 8001
Hydro Stop universal
socket encapsulation
collar
EPDM rubber
DN250-2000
Steel

- Options:
- pipe encapsulation collar
 - customised design and larger DN's



Series 8002
Hydro Fast dedicated
socket encapsulation
collar
EPDM rubber
DN300-2000
Steel

- Options:
- pipe encapsulation collar
 - customised design and larger DN's



Series 8003
Hydro Smart dedicated
socket encapsulation
collar
EPDM rubber
DN80-250
Steel

- Options:
- customised design



Series 748/01
Repair clamp
Single band
or AISI 316
NBR or EPDM rubber
Stainless steel AISI 304

- Options:
- handgrip



Series 748/02
Repair clamp
Double band
or AISI 316
NBR or EPDM rubber
Stainless steel AISI 304

- Options:
- handgrip



Series 748/03
Repair clamp
Triple band
NBR or EPDM rubber
Stainless steel AISI 304
or AISI 316



Series 712
Flanged bend
Ductile iron

- Options:
- various types



Series 712
Flanged cross
Ductile iron

- Options:
- various types



Series 712
Flanged reducer
Ductile iron

- Options:
- various lengths



Series 712
Reducer flange
Ductile iron



Series 712
Blind flange
Ductile iron

- Options:
- various types



Series 712
Duckfoot bend
Ductile iron

SMART WATER IOT SENSORS AND SOFTWARE



Series 3004/002
 VIDi Positioner
 Open/close position indicator for AVK extension spindles
 Wireless
 10-year battery life
 NB-IoT or LoRa® communication
 IP68



Series 3004/101
 VIDi Positioner
 Open/close position indicator for gate valves
 Wireless
 10-year battery life
 NB-IoT or LoRa communication
 IP68



Series 3002/002
 VIDi Cap
 Hydrant cap detecting open/close status
 For threaded Storz B outlet
 Wireless
 10-year battery life
 NB-IoT or LoRa® communication
 IP68



Series 3001/001
 VIDi Pressure
 Sensor measuring water pressure
 Wireless
 10-year battery life
 NB-IoT or LoRa® communication
 IP68 (transmitter)



Series 3001/002
 VIDi Flow
 Sensor transmitting water flow
 Wireless
 10-year battery life
 NB-IoT or LoRa® communication
 IP68 (transmitter)



Series 3001/004
 VIDi Level
 Sensor measuring distance to nearest surface
 Wireless
 10-year battery life
 NB-IoT or LoRa® communication
 IP68 (transmitter)
 IP67 (level sensor)



Series 3001/003
 VIDi Temperature
 Sensor measuring water temperature
 Wireless
 10-year battery life
 NB-IoT or LoRa® communication
 IP68 (transmitter)



Series 3004/001
 VIDi Open/Close
 Open/close position indicator for AVK valves
 Wireless
 10-year battery life
 NB-IoT or LoRa® communication
 IP68 (transmitter)



Series 3005/001
 Outdoor LoRaWAN®-gateway for series 3001, 3002 and 3004
 SIM card
 Ethernet (RJ45)
 IP67



Series 3005/002
 VIDi software for collecting and visualising data
 Access through standard web browser
 Unlimited number of units and users

- Options:
- VIDi Basic
 - VIDi Advanced
 - VIDi Premium

SUPPORT ACTIVE LEAKAGE CONTROL WITH VIDI POSITIONER

Knowing if and when DMA boundary valves are operated is important, as this commonly influences non-revenue water (NRW) management. HOFOR, the largest utility company in Denmark, has therefore installed VIDI Positioners for remote monitoring of valve open/close positions.

Increased reliability

Flow meters on DMA inlet pipes and shut-off valves on the pipes connecting DMAs enable water balance calculations at DMA level. Accurate calculations rely on robust, precise and complete data where all water entering and leaving a DMA is monitored and measured.

Such calculations highly depend upon valid information confirming that all boundary valves are closed during the water balance assessment period. It is a well-known problem, that boundary valves opened during maintenance work, sometimes are not brought back to closed position afterwards.

Thus, monitoring the open/closed position can help prevent unmeasured flow between DMAs and thereby provide more reliable data and calculations.

Improved overview

VIDI Positioners have been installed at three strategically important boundary valves between DMAs in HOFOR's distribution area. VIDI Positioner is an IoT sensor that indicates in percentages how much the valve is open and reports any operating activities. At regular intervals and whenever the valve is operated, data is automatically sent to the utility and integrated with their GIS.

Data is further integrated with a management information system directly connected with the hydraulic model where the hydraulic simulations then automatically will reflect the change in valve position. Further, water balance calculations will be disabled during periods where the DMA boundary valves are open. This way, VIDI Positioner allows for a better overview and automated knowledge sharing.



SUSTAINABILITY AT AVK



We contribute actively to the UN SDGs

Our solutions contribute to the UN sustainable development goals by ensuring clean water and sanitation, by reducing water waste, electricity consumption and CO2 emissions, and by turning wastewater into affordable and clean energy. Our valve design is not only optimised to ensure long durability and 100% tightness; it also offers low operating torque, allowing for the use of cost-efficient electrical actuators.

AVK has entered into partnerships with other leading Danish companies aimed at sharing knowledge within water technology and at offering joint solutions for a more sustainable world. Furthermore, to help implement the already known and well-proven technologies, we have founded and host a summer school which runs under the name "Advanced Water Cycle Management Course". With the latest knowledge at hand and a holistic approach to the journey of water through society, we focus on obtaining the most efficient supply and treatment processes.

Environmental efforts

At the AVK Advanced Castings foundry, supplying the AVK Group with castings for valves and hydrants and other metal castings, we use the innovative lost foam method, and this method allows for an improvement in performance, reducing energy consumption and the amount of particle emissions into the



atmosphere. In our castings, we use recycled steel scrap as the principal component – up to 85-90% of the total melt.

The AVK Group has strict requirements and standards for energy and water consumption its production companies must meet. Consequently, all companies make great efforts to reduce consumption wherever they can.

Global responsibility

AVK is a global company operating worldwide and must as such take different circumstances and conditions in different countries into account and the consequent risks. In all countries where AVK is present, it is fundamental to act responsibly towards employees, environment and the surrounding society.

The AVK Group keeps a close watch on all business units and ensures through regular visits that all AVK companies comply with the defined principles. Whatever country or location, we focus on the health and safety of our employees. We carefully monitor the number of work-related accidents and work proactively on preventive measures. The result of this is a steady decline in the number of accidents. We also ensure maintenance, inspection and development of working conditions, equipment and tools that are necessary to complete a given business process.

The AVK Group has agreed to adhere to standards that our suppliers must adhere to as well in order to become a certified supplier of the Group. Sustainability is vital for us throughout the entire supply chain. Therefore, we only cooperate with partners with high ethical standards, who are strongly committed to comply with international legislation in the field of labour.

AVK International A/S

Bizonvej 1
Skovby
8464 Galten
Denmark

Tel.: +45 8754 2100
www.avkvalves.eu

2025.04.01
© 2025 AVK Group A/S - rev. 4

Expect... **AVR**