

AVK DAMS, RESERVOIRS & HYDROPOWER SOLUTIONS



DAMS, RESERVOIRS & HYDROPOWER VALVE SOLUTIONS

Expect... **AVR**



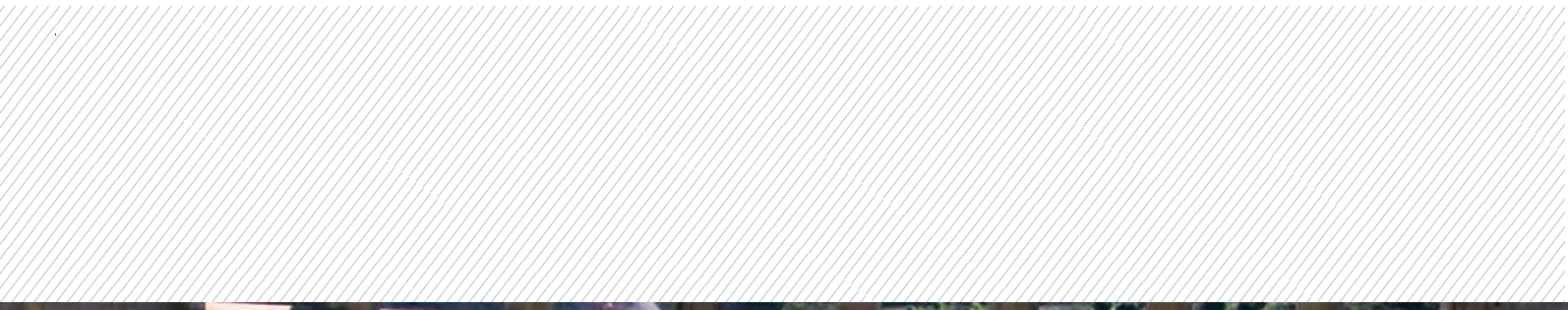

CONTENTS



TECHNICAL CAPABILITIES	4 - 5
APPLICATION MATRIX	6 - 7
BOTTOM OUTLETS	8
INTERMEDIATE OUTLETS	9
SPILLWAYS & CANALS	10
HYDROPOWER STATIONS & REVERSE PUMPED STORAGE	11
PRODUCT RANGE	12 - 13
SUPPLY SOLUTION PROVIDER	14

EXPECT GLOBAL LEADERSHIP & LOCAL COMMITMENT

Whatever you may need, we can provide

Together, Orbinox Valves International, Glenfield Valves Ltd, Premier Valves, Gunric Valves and ACMO, leading global valve manufacturers and part of the AVK Group, form a combined wealth of experience, expertise and resource to globally develop the AVK Dams, Reservoirs and Hydro Power Sector.

Our common product portfolio comprises a large and comprehensive range of valves, including bonneted gate valves, radial and roller gates, discharge valves, large diameter knife gates valves, butterfly valves, check and recoil valves, gate valves, needle valves, spherical and boving valves, etc. for the Dams, Reservoirs & Hydro Power segments.

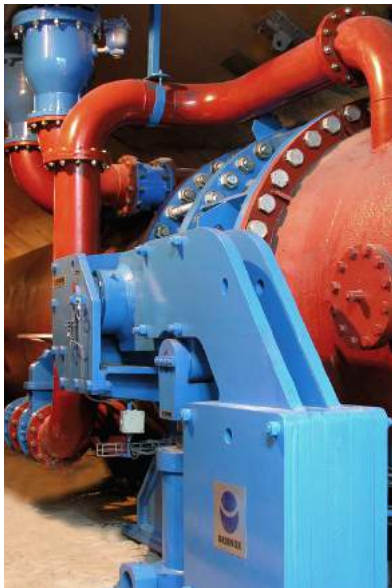

Wherever you are, so are we

Our geographical presence and product range may be global, but our focus is local. We stay close to our customers throughout the entire process. The proximity allows us to better understand our customers' needs and tailor our solutions to fit them.

Being a global player, we are able to provide highly engineered products and service solutions approved to international standards whilst always understanding and adapting to local specifications and project requirements.







EXPECT QUALITY & A LONG-TERM PARTNERSHIP





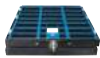







Quality is essential! When it comes to valves, hydrants, fittings and Accessories, our customers expect long lasting solutions.

We build on and invest in long-term partnerships, because our customers are much more valuable than a single transaction.



APPLICATION MATRIX







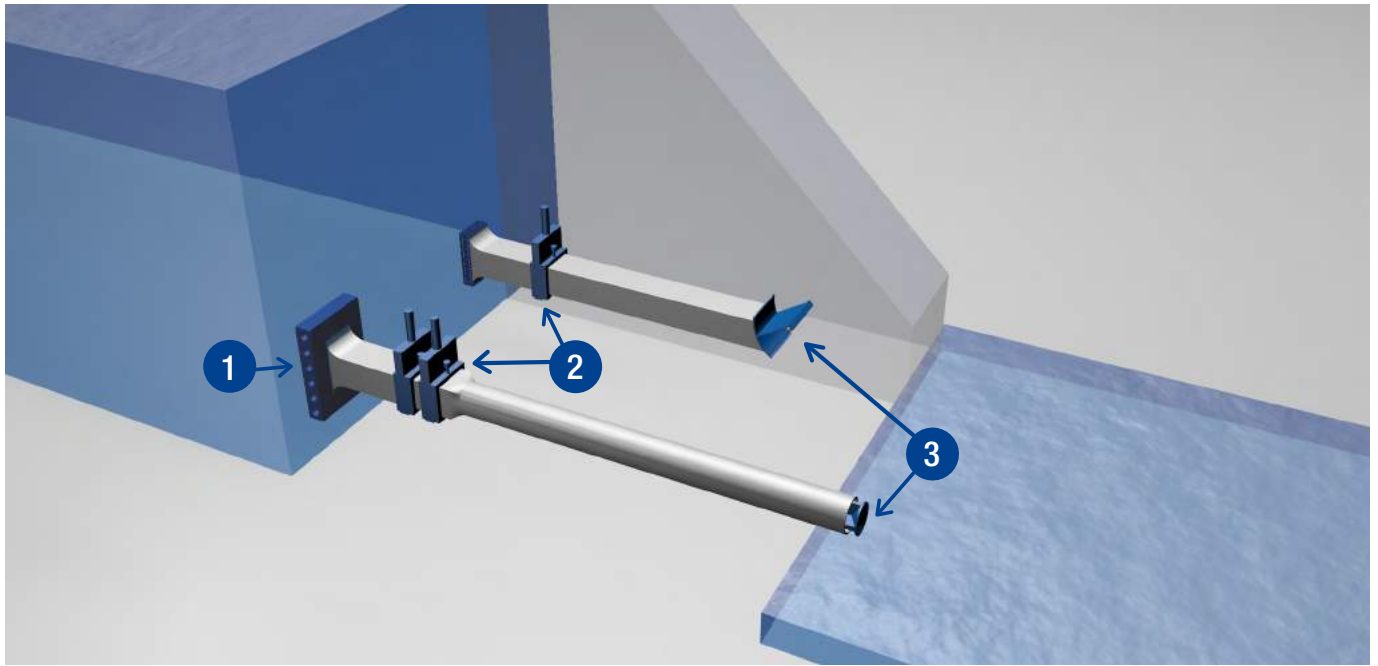



<h2>VALVE TYPE</h2>	Bonneted Gate	Radial Gate	Roller Gate	Stop Gate	Penstock / Sluice Gate	Free Discharge	Submerged Discharge
Bottom Outlets							
Intake Gate			•				
Guard Valve	•						
Discharge Valve		•				•	•
Intermediate Outlets							
Intake Tower							
Intake			•				
Intermediate Outlet							
Intake Gate			•				
Guard Valve	•						
Control / Discharge Valve		•				•	•
Spillways & Canals							
Spillway							
Gate		•	•	•	•		
Canal							
Gate		•	•	•	•		
Hydro Power & Reverse Pumped Storage							
Hydro Power Station							
Intake Control	•	•	•		•		
Turbine Protection			•				
Turbine Bypass / Tailrace	•					•	•
Reverse Pumped Storage							
Reverse Pumped Storage	•						
							

Fabricated Butterfly	Butterfly	High Performance Butterfly	Knife Gate	Wedge Gate e	High Performance Gate	Tilting Disc / Butterfly Check	Recoil Check	Slanted Seat Check	Needle Control	Automatic Control	Air	Spherical
		•	•	•						•	•	
									•			
		•	•	•						•	•	
	•	•		•	•				•	•	•	
•	•	•	•	•						•	•	
•	•	•									•	•
			•	•					•	•	•	•
•	•	•	•	•		•	•	•		•	•	•
												

APPLICATION









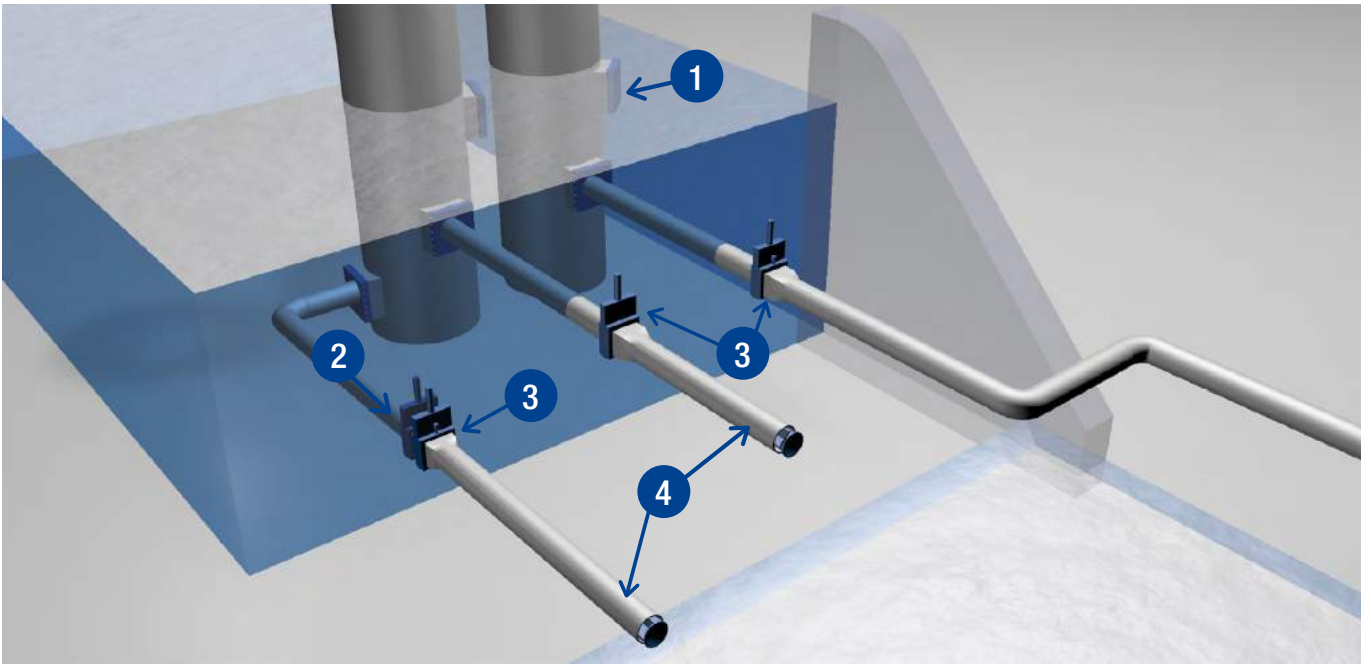











BOTTOM OUTLETS

	Bonneted Gate	Radial Gate	Roller Gate	Free Discharge	Submerged Discharge	High Performance Butterfly	Knife Gate	Wedge Gate	Needle Control	Automatic Control	Air
1 Intake Gate											
2 Guard Valve											
3 Discharge Valve											

APPLICATION





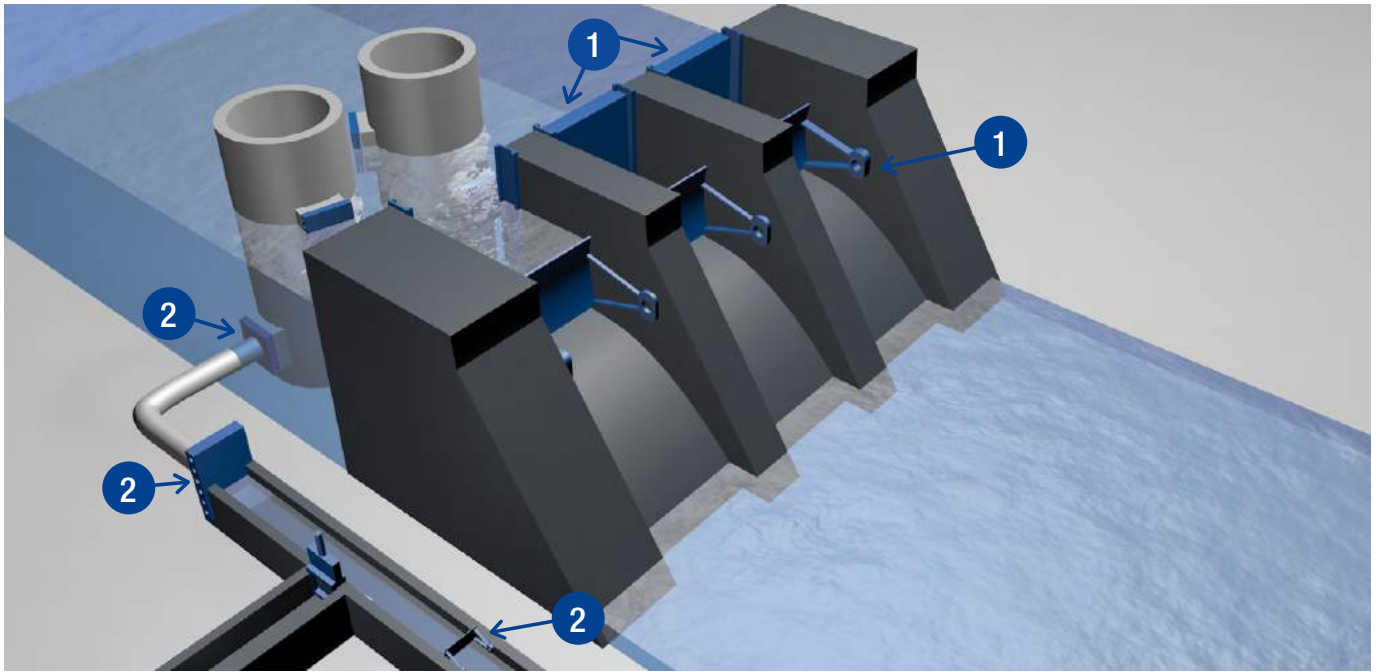

INTERMEDIATE OUTLETS

	Bonneted Gate	Radial Gate	Roller Gate	Free Discharge	Submerged Discharge	Butterfly	High Performance Butterfly	Knife Gate	Wedge Gate	High Performance Gate Valve	Needle Control	Automatic Control	Air Valve
Intake Tower													
1 Intake Gate													
Intermediate Outlet													
2 Intake Gate													
3 Guard Valve													
4 Control / Discharge Valve													

APPLICATION



SPILLWAYS & CANALS

	Radial Gate	Roller Gate	Stop Gate	Penstock / Sluice Gate
Spillways & Canals				
1 2 Gate				

APPLICATION

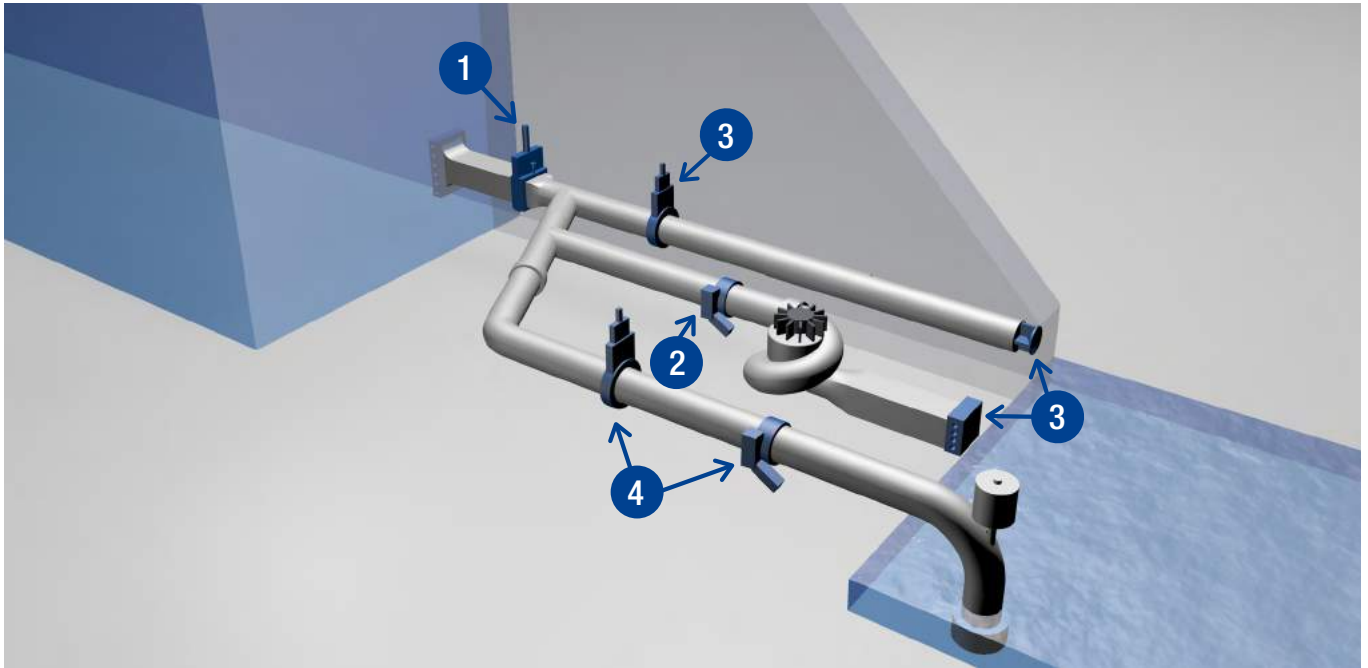

HYDROPOWER STATIONS AND REVERSE PUMPED STORAGE

	Bonneted Gate	Radial Gate	Roller Gate	Penstock / Sluice Gate	Free Discharge	Submerged Discharge	Fabricated Butterfly	Butterfly	High Performance Butterfly	Knife Gate	Wedge Gate	Tilting Disc / Butterfly Check	Recoil Check	Slanted Seat Check	Needle Control	Automatic Control	Air Valve	Spherical
Hydro Power Station																		
1 Intake Control																		
2 Turbine Protection																		
3 Turbine Bypass / Tailrace																		
Reverse Pumped Storage																		
4 Reverse Pumped Storage																		

PRODUCT RANGE



Bonneted Gate

Carbon or stainless steel fabricated body and gate, bronze seat and hydraulic or electric actuation.

Specifics

Size
Up to 2500 x 3500 mm

Pressure
Up to 20 bar



Radial Gate

Carbon or stainless steel fabricated gate, three or four side sealing with elastomer seals and hydraulic or electric actuation.

Specifics

Size
Up to 20000 x 7000 mm

Pressure
Gate height

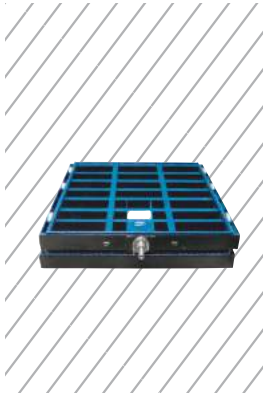

Roller Gate

Carbon steel fabricated gate, roller system for guiding purposes, elastomer seals and hydraulic or electric actuation.

Specifics

Size
Up to 6000 x 8000 mm

Pressure
Up to 10 bar

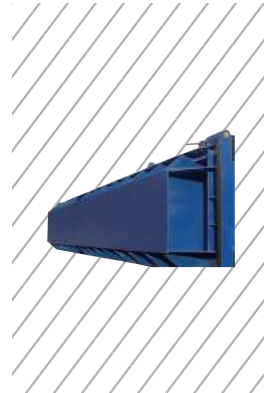

Stop Gate

Carbon steel fabricated gate, elastomer seals, normally operated with auxiliary lifting equipment/ crane.

Specifics

Size
Up to 20000 x 7000 mm

Pressure
Gate height



Penstock / Sluice Gate

Three and four side sealing. Stainless steel full frame and gate, EPDM seals, HMWPE guides and various actuation solutions (manual, pneumatic, electric... etc).

Specifics

Size
Up to 4000 x 4000 mm

Pressure
4-side: 1 bar on / 0,6 bar off
3-side: Gate height

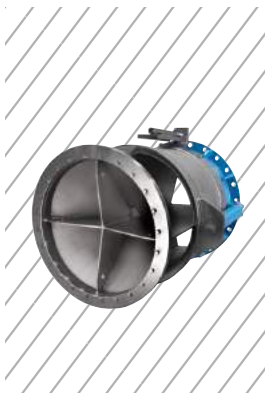

Free Discharge Valve

Cast body or carbon steel / stainless steel fabricated body, elastomer seat and hydraulic or electric actuator.

Specifics

Size
Up to DN3000

Pressure
Up to 20 bar



Submerged Discharge Valve

Terminal discharge valve providing submerged energy dissipation and flow control. Type – End of line single flanged.

Specifics

Size
DN200 – 1800

Pressure
10 & 16 bar



Fabricated Butterfly Valve

Carbon or stainless steel fabricated body and disc, elastomer seal and hydraulic or electric actuator.

Specifics

Size
Up to DN3500

Pressure
Up to 10 bar (DN3500)
Up to 16 bar (DN2000)
Up to 25 bar (DN1000)



Butterfly Valve

Double eccentric butterfly valve with seal on disc design. Fully bi-directional with drop tight shut off and double flanged connection.

Specifics

Size
DN200 – 2800

Pressure
PN10, 16 & 25 bar

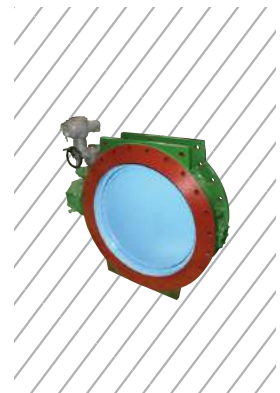

High Performance Butterfly Valve

Boving type double eccentric resilient seal on disk and stainless steel body seat. Drop tight shut-off in preferred direction and double flanged connection.

Specifics

Size
DN100 – 3000

Pressure
PN10, 16, 25 & 40 bar

PRODUCT RANGE

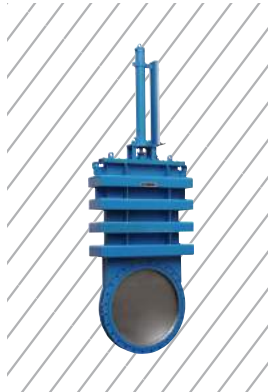

Knife Gate Valve

Bonneted valve, carbon or stainless steel fabricated body bonnet and gate, elastomer or bronze seat and hydraulic or electric actuation.

Specifics
Size Up to DN3500
Pressure Up to 20 bar



Wedge Gate Valve

Metal seated gate valve for isolation. Double Flanged (PN 25 available in certain sizes).

Specifics
Size DN50 – 2400
Pressure 10 & 16 bar



High Performance Gate Valve

Heavy duty ductile iron or steel cast valve, with weld deposit seats, extruded dovetail channel guides and shoes, and thrust bearings.

Specifics
Size DN80 – 1800
Pressure PN10, 15, 25, 40 & 64 bar



Tilting Disc / Butterfly Check Valve

Carbon or stainless steel fabricated body and disc, metal or elastomer seat and optional hydraulic damper and counterweight.

Specifics
Size Up to DN2000
Pressure Up to 16 bar



Recoil Check Valve

Metal seated high performance, fast acting, non slam check valve.

Specifics
Size DN50 - 1400
Pressure PN10, 16 & 25 bar



Slanted Seat Check Valve

Three piece design with replaceable central section, with multiple doors for rapid closing times without slamming and high pressure flushing for cleaning.

Specifics
Size DN500 – 2000
Pressure PN10, 16, 25 & 40 bar



Needle Control Valve

Flow, level and pressure control valve used for in-line and terminal applications.

Specifics
Size DN80 – 2000
Pressure PN10, 16, 25, 40, 64 & 100 bar

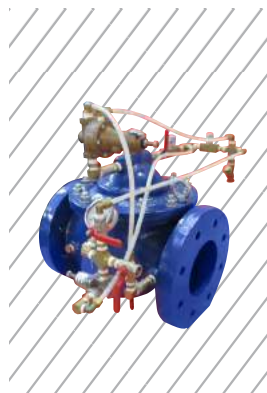

Automatic Control Valve

Ductile iron body / bonnet and stainless steel body seat globe / diaphragm type valve. Large passageways for higher flow rates and greater cavitation resistance.

Specifics
Size DN50 – 500
Pressure PN10, 16, 25 & 40 bar



Air Valve

Triple function ventilation air valves with aerokinetic performance. Large discharge capacities and drop tight shut off for full pressure range.

Specifics
Size DN25 – 250
Pressure PN10, 16 & 25 bar



Spherical Valve

Cast or fabricated, metallic / soft designs, with movable service seal. Counterweight / hydraulically operated with digital instrumentation systems.

Specifics
Size DN300 - 2000
Pressure PN10, 16, 25, 40 & 64 bar

SOLUTION PROVIDER

Working with our international supply chain partners, we are ready to support your projects wherever you are!



ORBINOX is present in more than 70 countries with over 50 years of experience designing, manufacturing and marketing knife gate valves, penstocks, dampers and valves for hydraulic works.

Product quality and customer satisfaction are our goals. We have a highly qualified and experienced team providing the best solutions to suit the needs of our customers.

Our global presence enables us to be close to our customers in order to offer technical advice and respond to their requirements. We think globally, whilst applying local expertise.



Glenfield Valves located in Scotland since 1852 have been designing and manufacturing specialist engineered valves for more than 150 years. Our products are installed worldwide in dams, reservoir and hydropower applications.

Providing engineered valve solutions ranging from 50mm to 3000mm according to most of the worlds international design standards has made the Glenfield name synonymous with engineering excellence worldwide.

Our team of highly qualified engineers and project managers are available to assist in the design, procurement, installation and planned maintenance of a complete range of AVK Group products.



The **Premier Valves Group (PVG)** is one of Africa's largest and longest established valve suppliers, that specialises in the manufacture of large bore, high pressure, engineered valve products for both bulk water supply & power/ industrial applications.

PVG is based in its own 46,000 sqm factory facility outside Johannesburg, and also offers valve factory repair and refurbishment services, as well as, on site installation, commissioning and preventative maintenance services.



Gunric Valves, is a premium industrial valve supplier, providing customised butterfly and check valves for unique industrial applications.

Gunric is recognised internationally as a leading manufacturer of butterfly and tilting disk check valves.

Built for extreme pressure and temperature applications, products from Gunric are ideally suited for the water, oil, process, mining, power generation, petrochemical, gas, sugar and steel industries.



ACMO designs and manufactures hydraulic equipment for water distribution, water transmission, irrigation and water treatment. The ACMO Group support and develop technologies which combine to make efficient and safe systems for the management of water ecosystems.

ACMO operates across five office locations and over 10 international agencies. Thanks to its acquired know-how in water projects, ACMO provide information and assistance, with specific studies for the update of installed equipment.

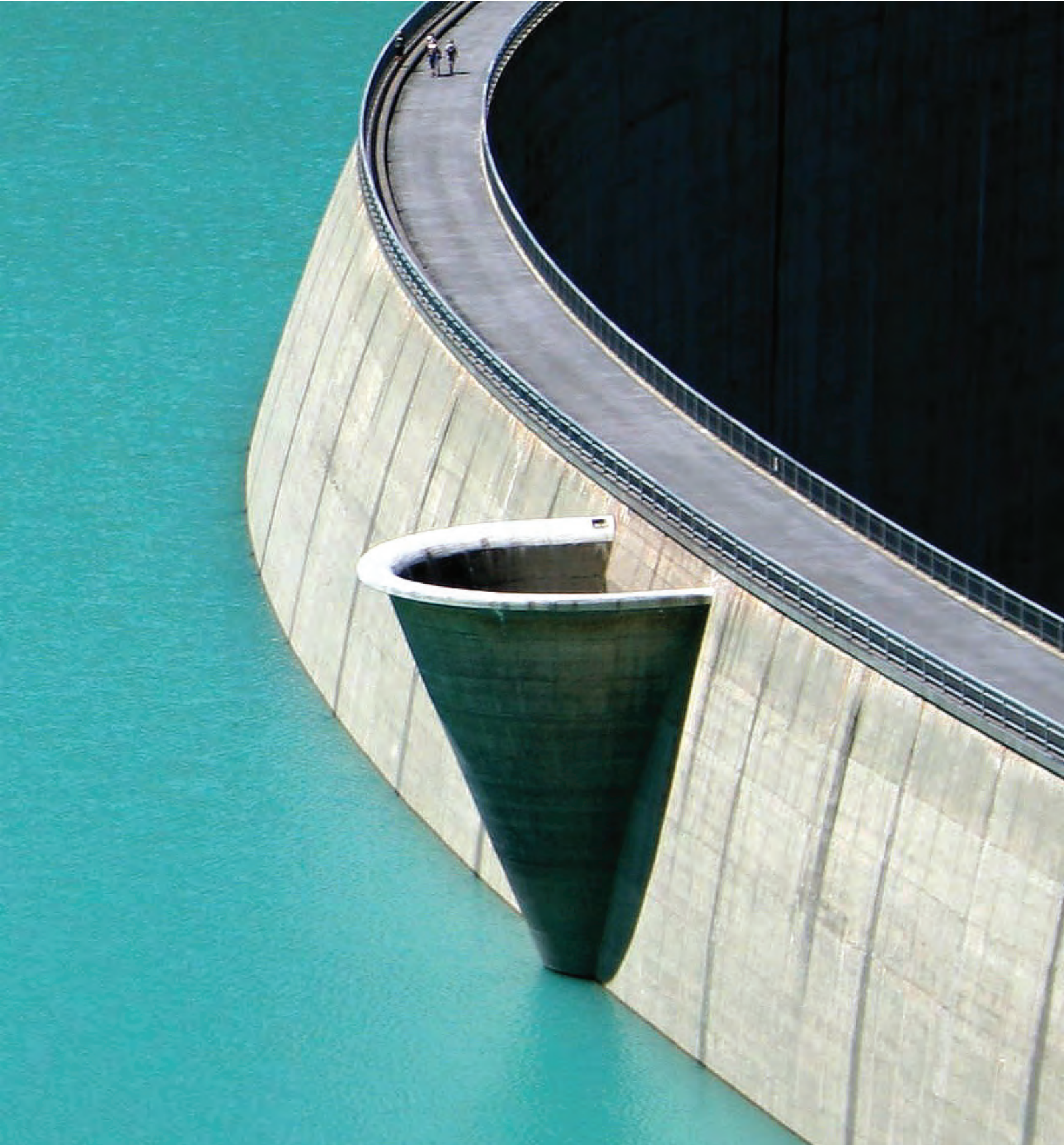

PT. AVK Fusion Indonesia

Taman Tekno Blok F1/F-CDE
BSD City, Serpong,
Tangerang Selatan,
Banten 15314

Tel.: +62-21-75682627
Fax: +62-21-75682628
<https://www.avkfusion.co.id>
customercare@avkfusion.co.id

Copyright©AVK Fusion Indonesia 2023

Expect... **AVR**